

Fig. 1.

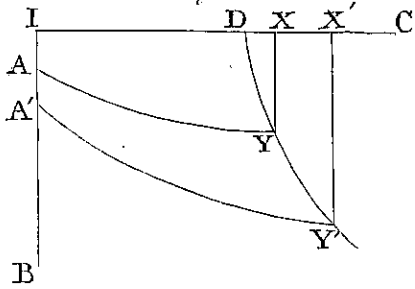

Fig. 2.

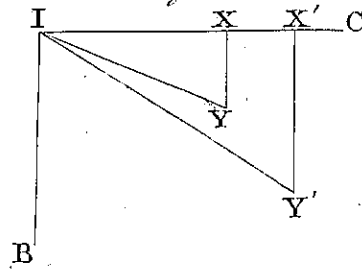

Fig. 3.

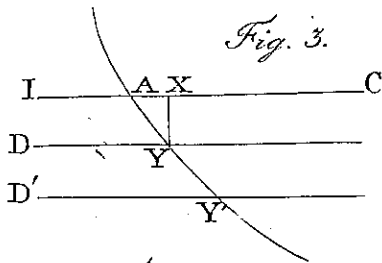

Fig. 4.

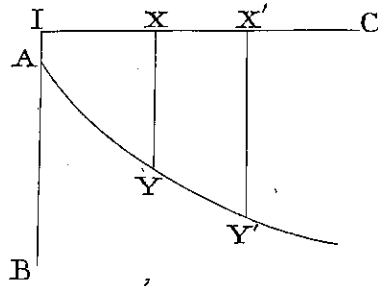

Fig. 5.

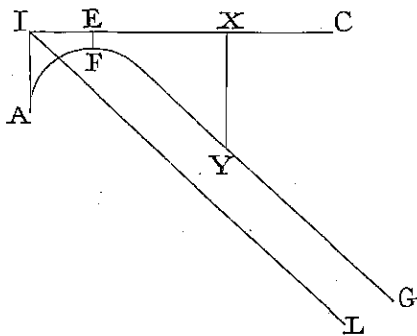

Fig. 6.

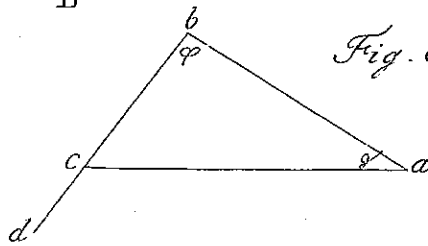

Fig. 7.

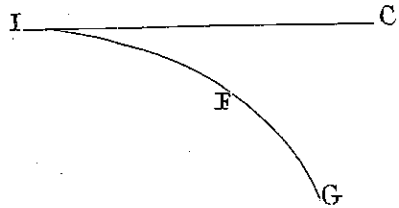
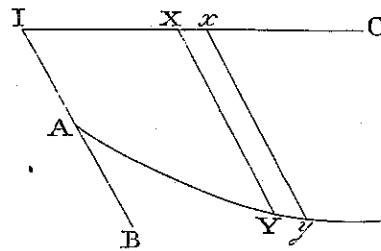

Fig. 8.



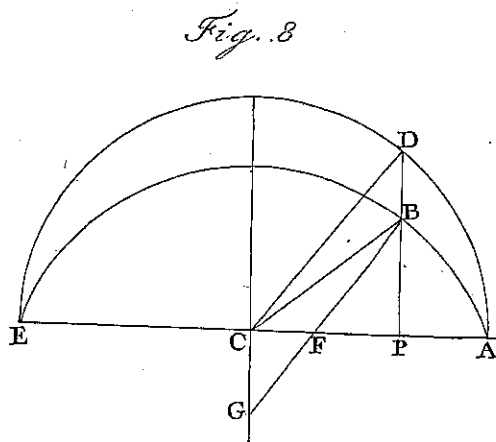
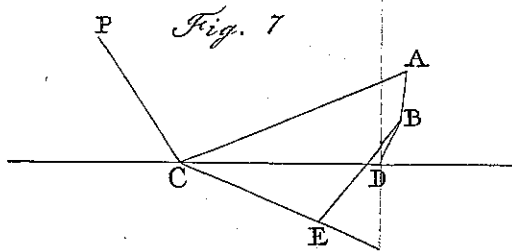
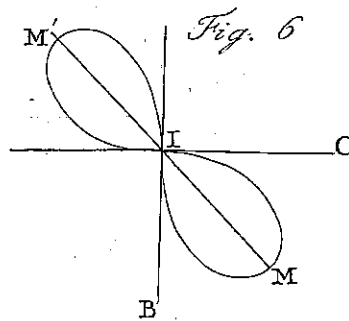
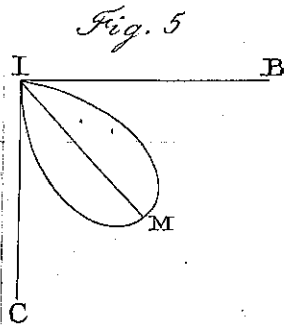
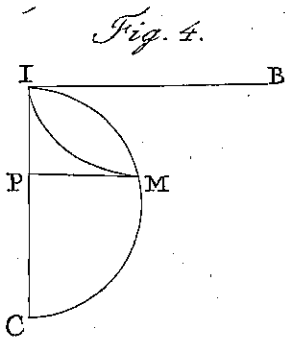
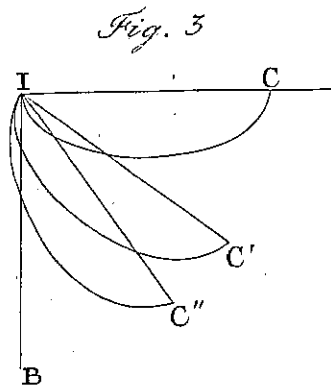
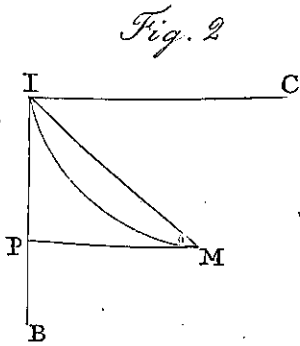
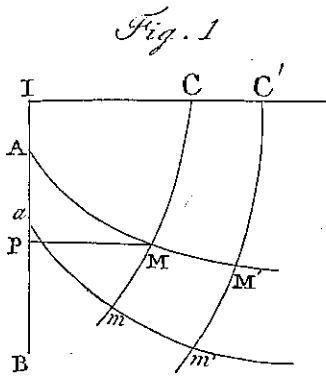

Fig. 1.

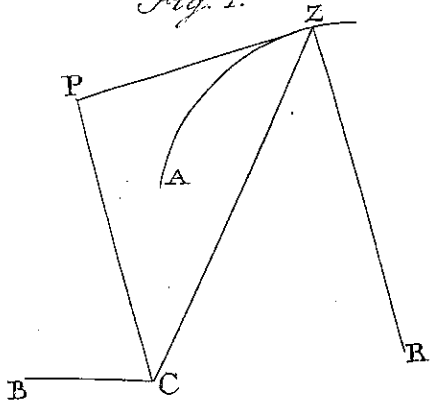

Fig. 2.

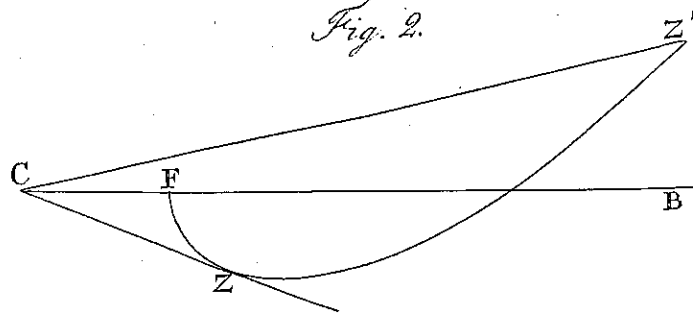

Fig. 3.

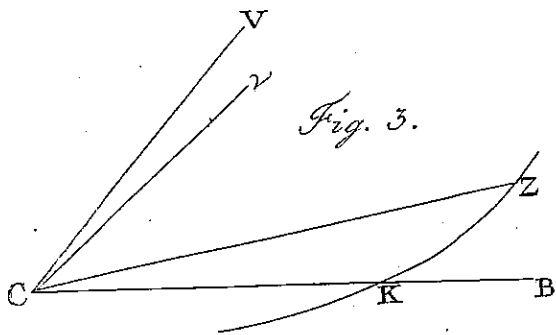

Fig. 4.

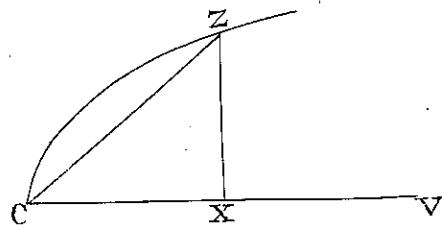

Fig. 5.

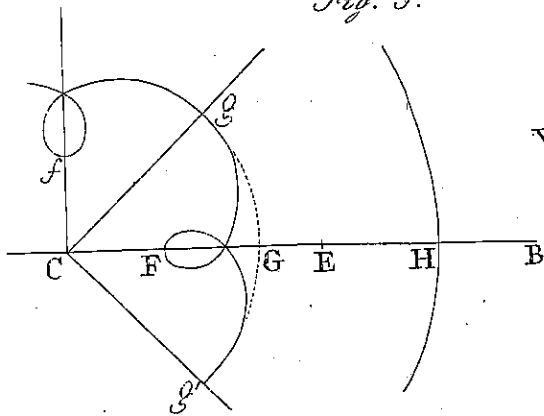

Fig. 6.

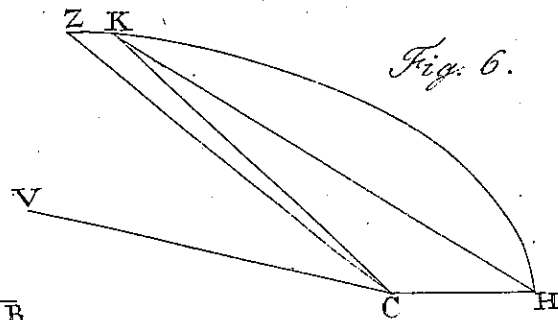

Fig. 1.

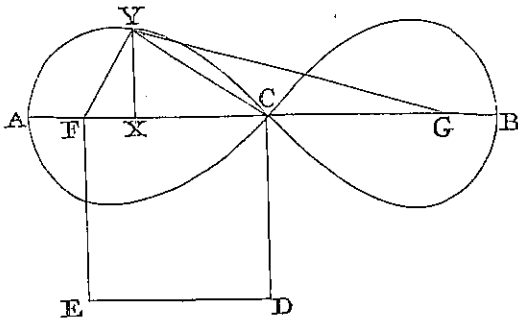

Fig. 2.

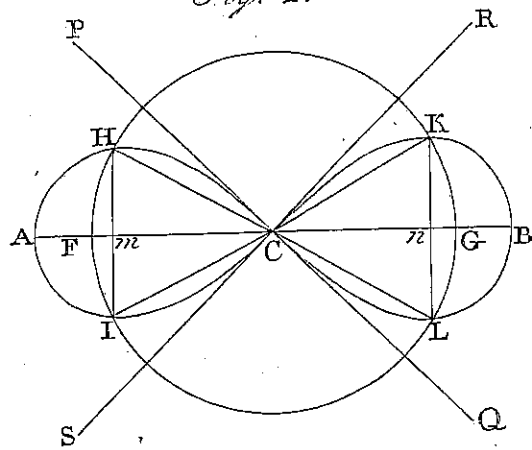

Fig. 3.

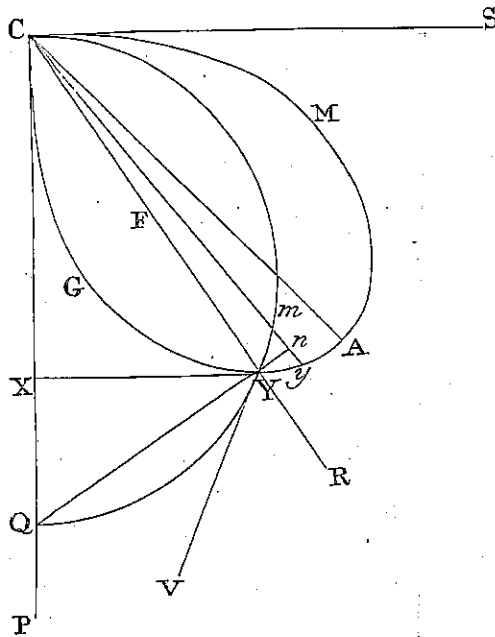

Fig. 4.

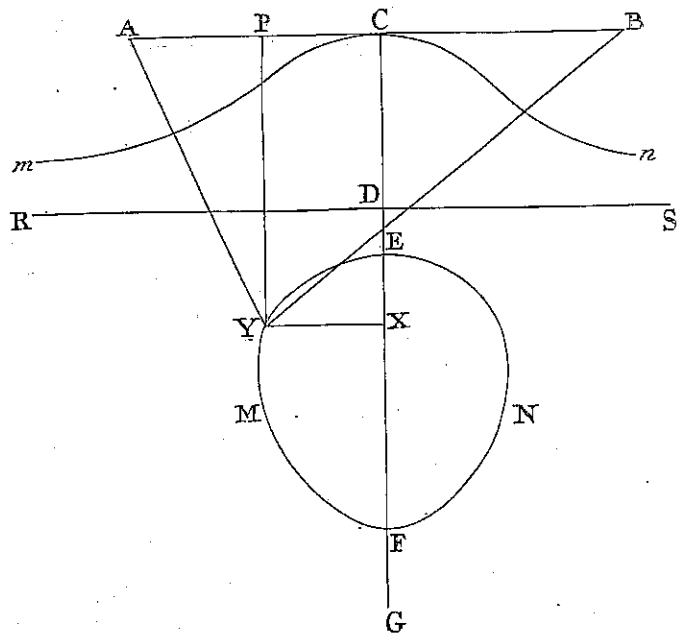
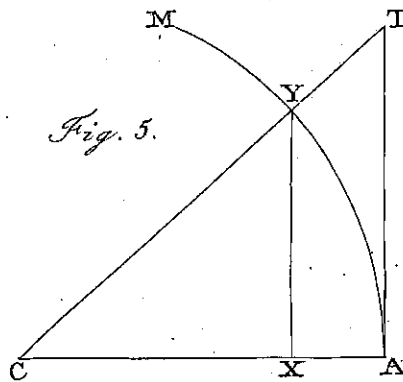
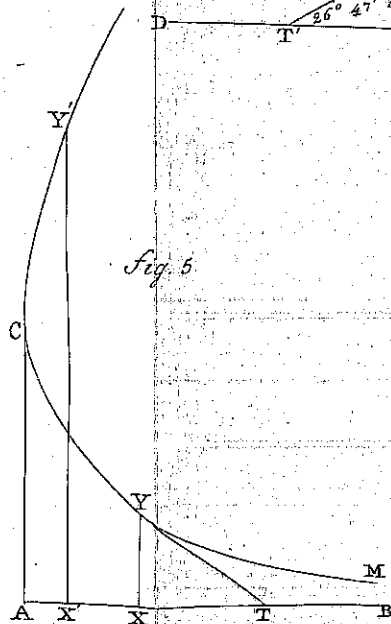
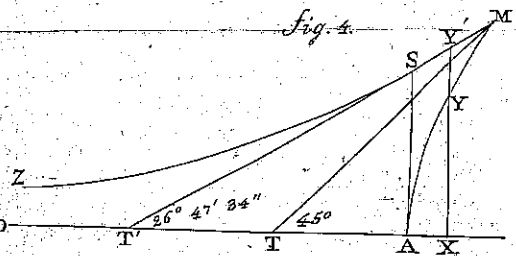
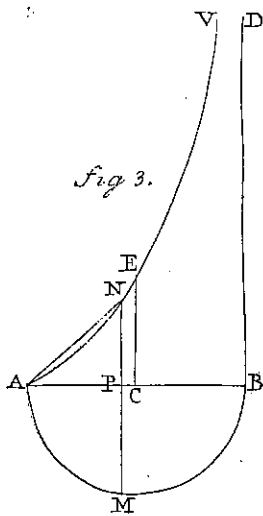
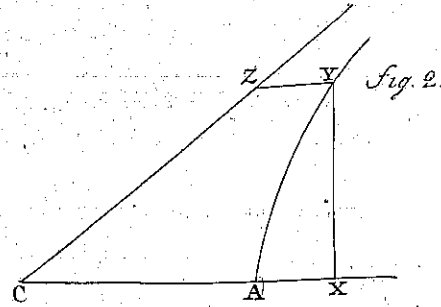
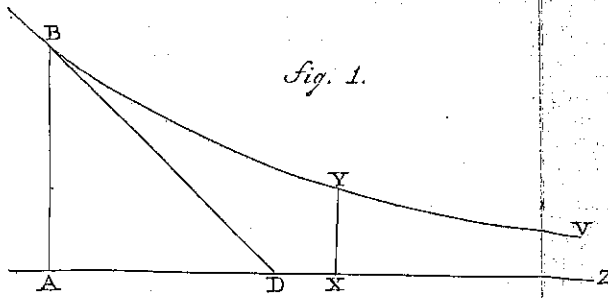

Fig. 5.





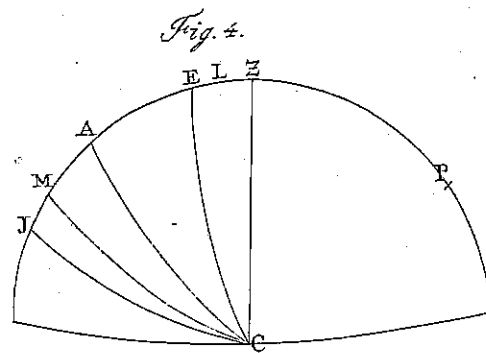
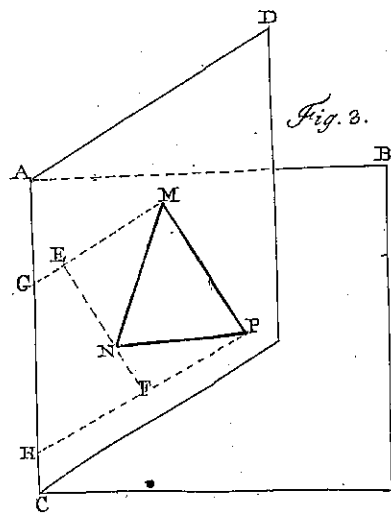
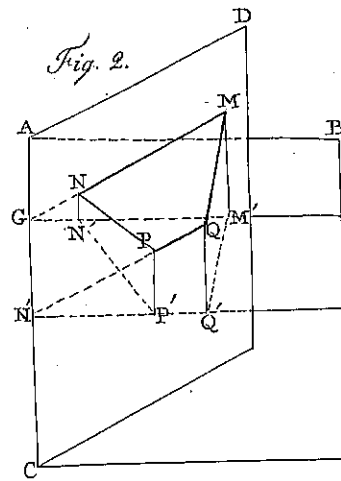
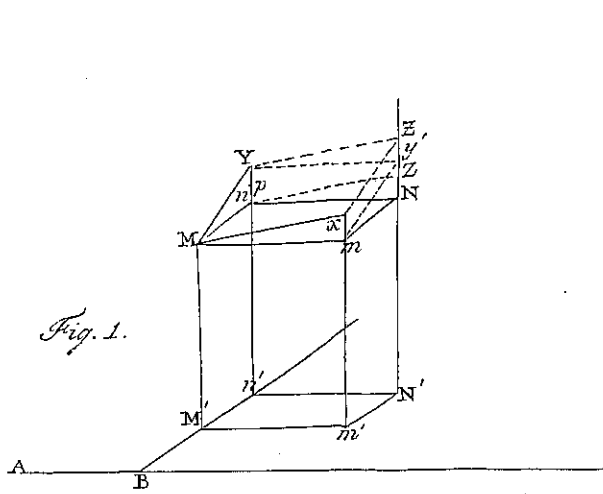

Fig. 1. ^{cro}

