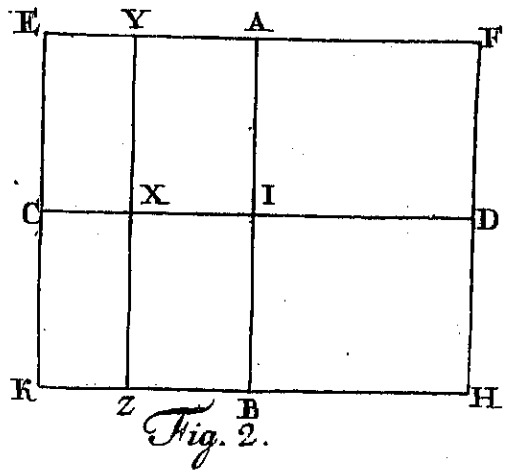
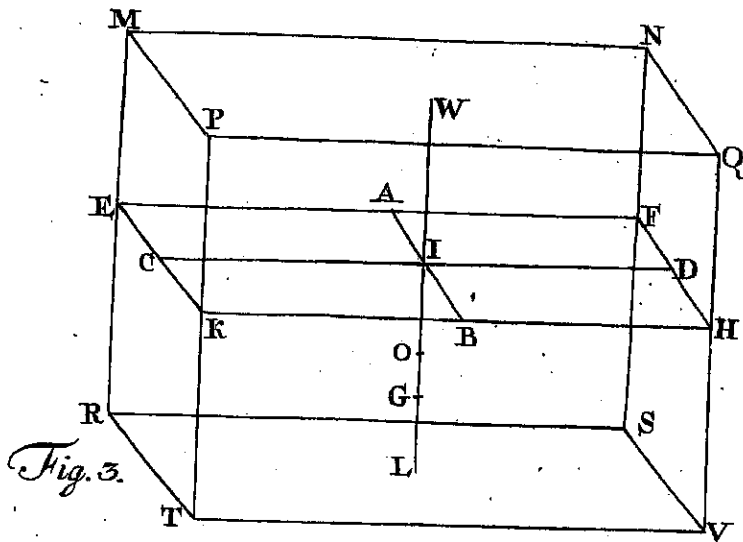


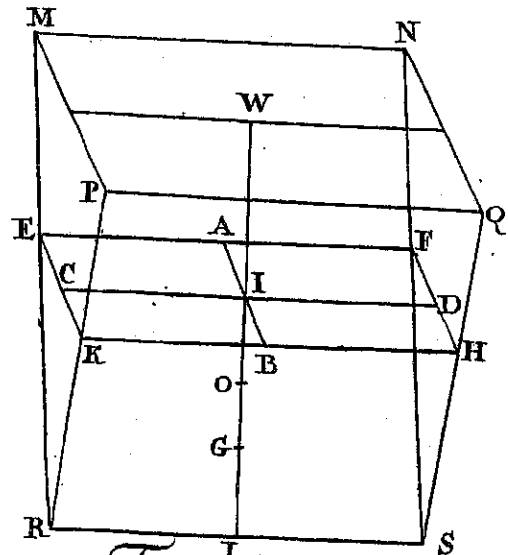
*Fig. 1.*



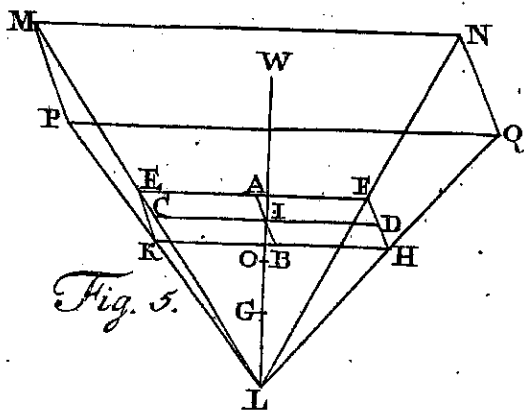
*Fig. 2.*



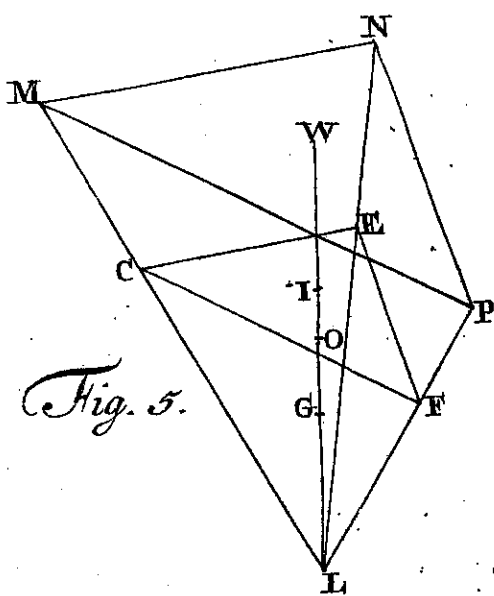
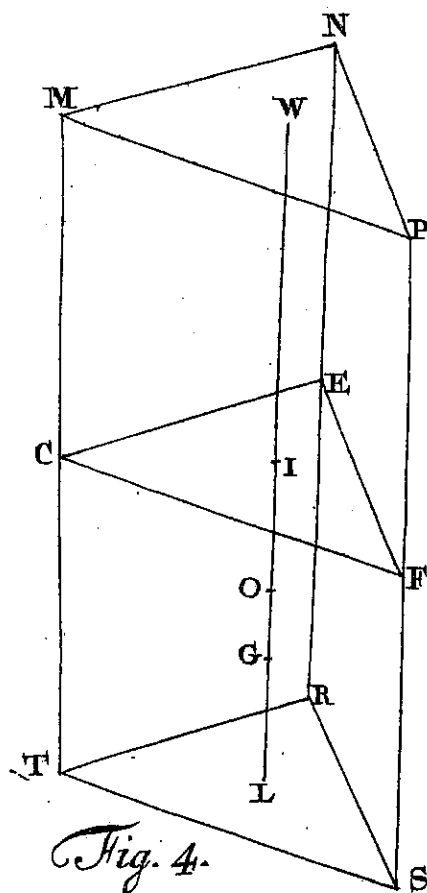
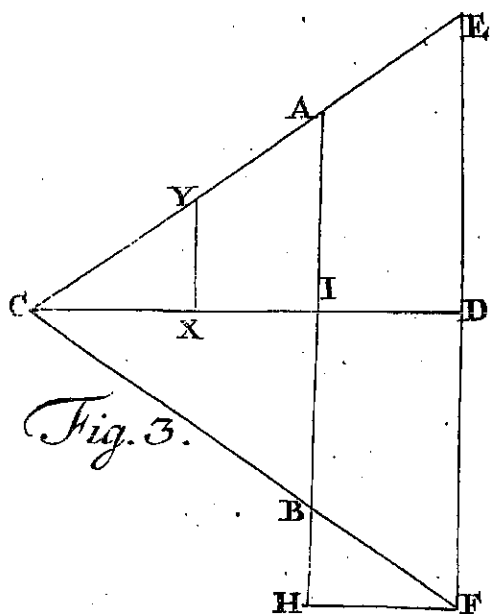
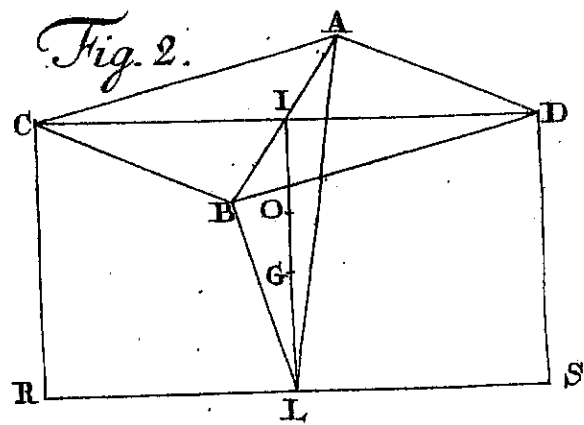
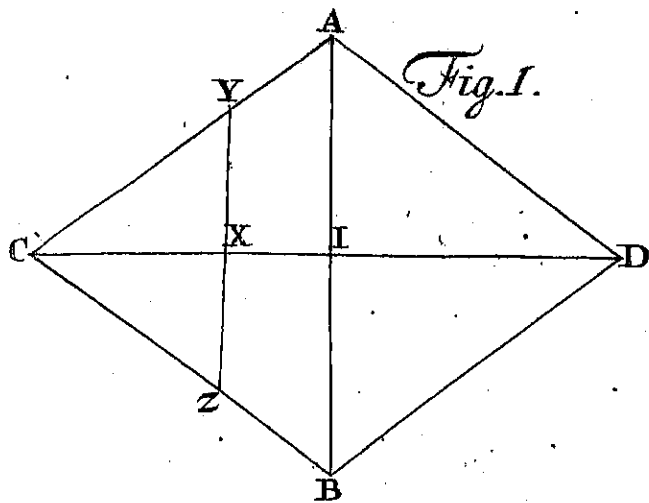
*Fig. 3.*

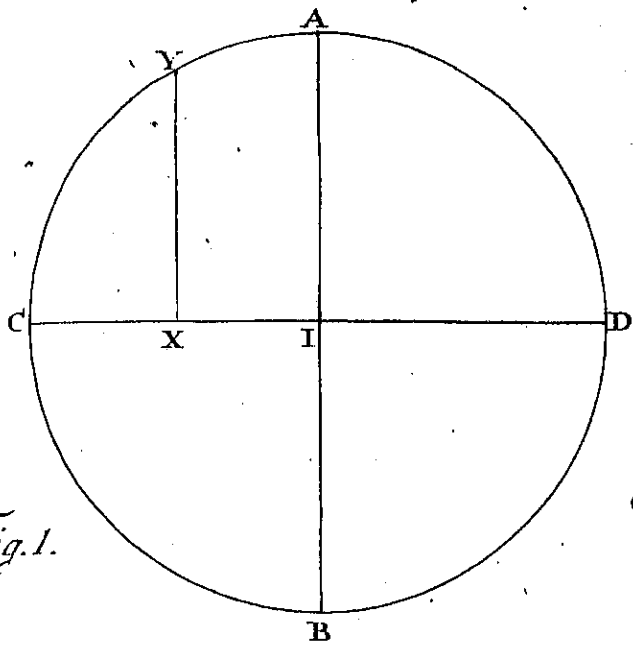


*Fig. 4.*

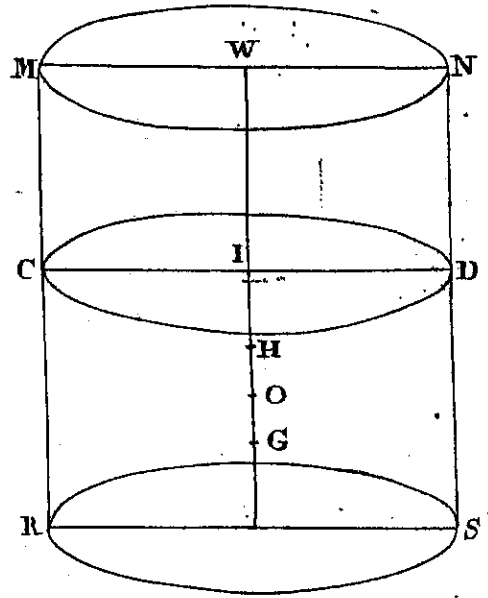


*Fig. 5.*

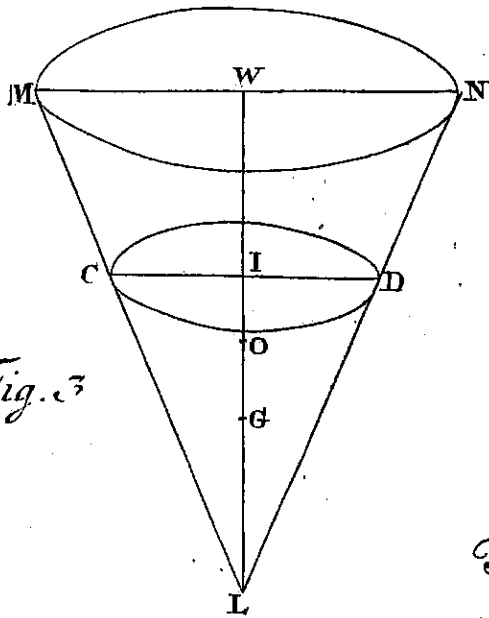




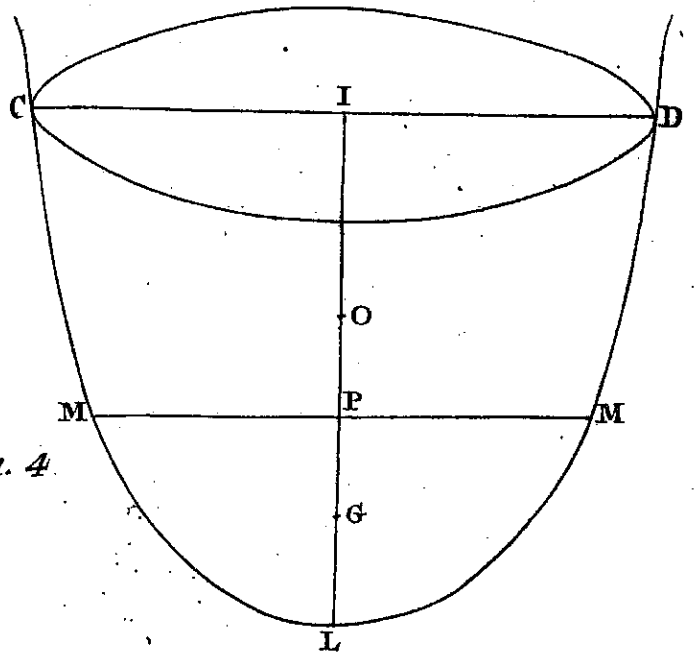
*Fig. 1.*



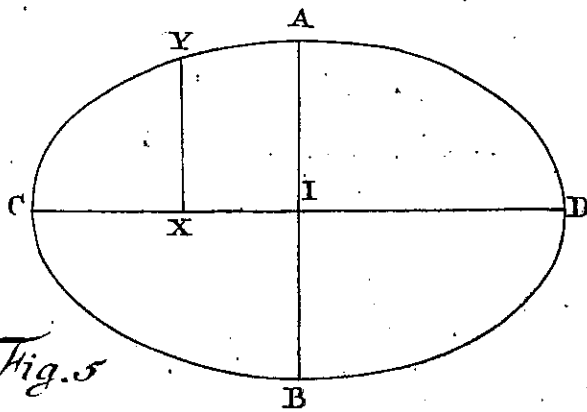
*Fig. 2.*



*Fig. 3.*

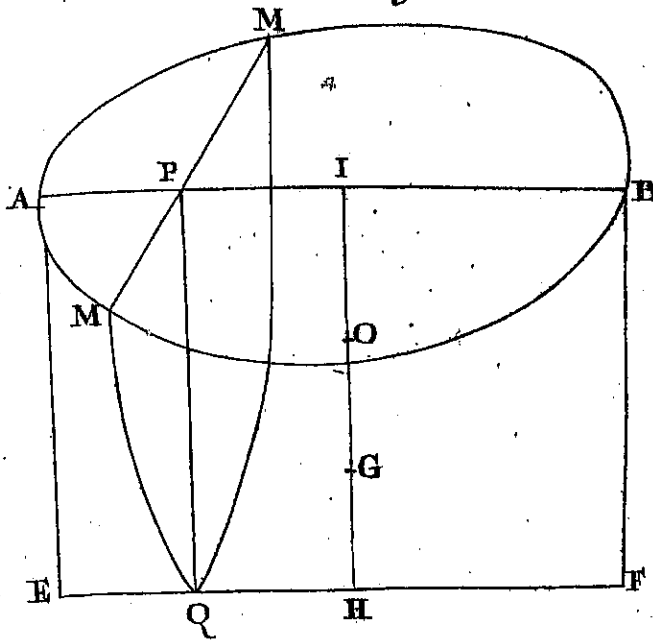


*Fig. 4.*

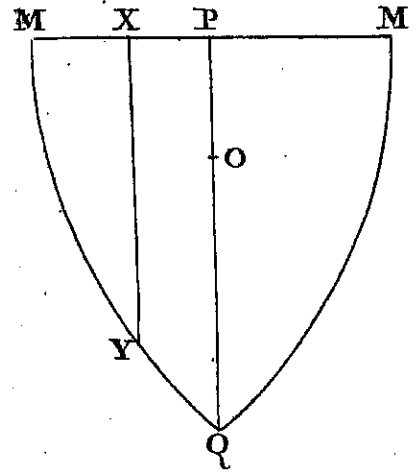


*Fig. 5.*

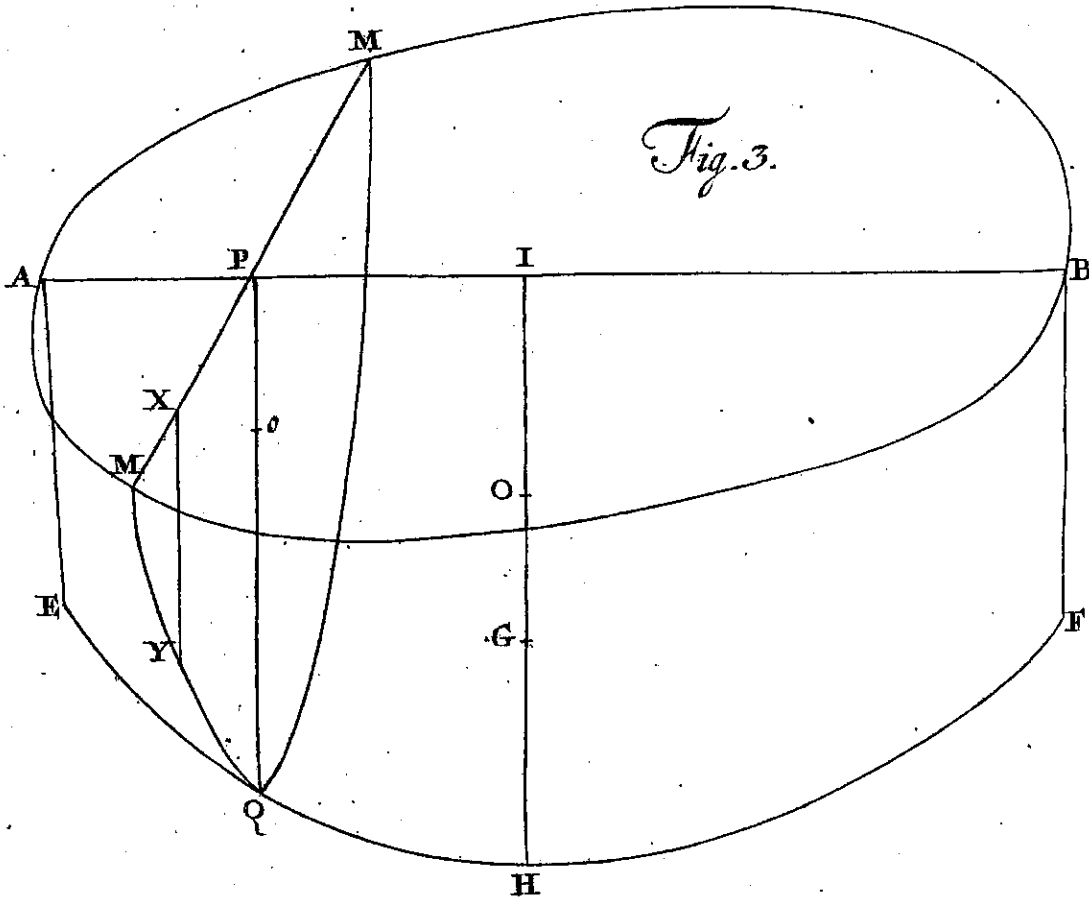
*Fig. 1.*

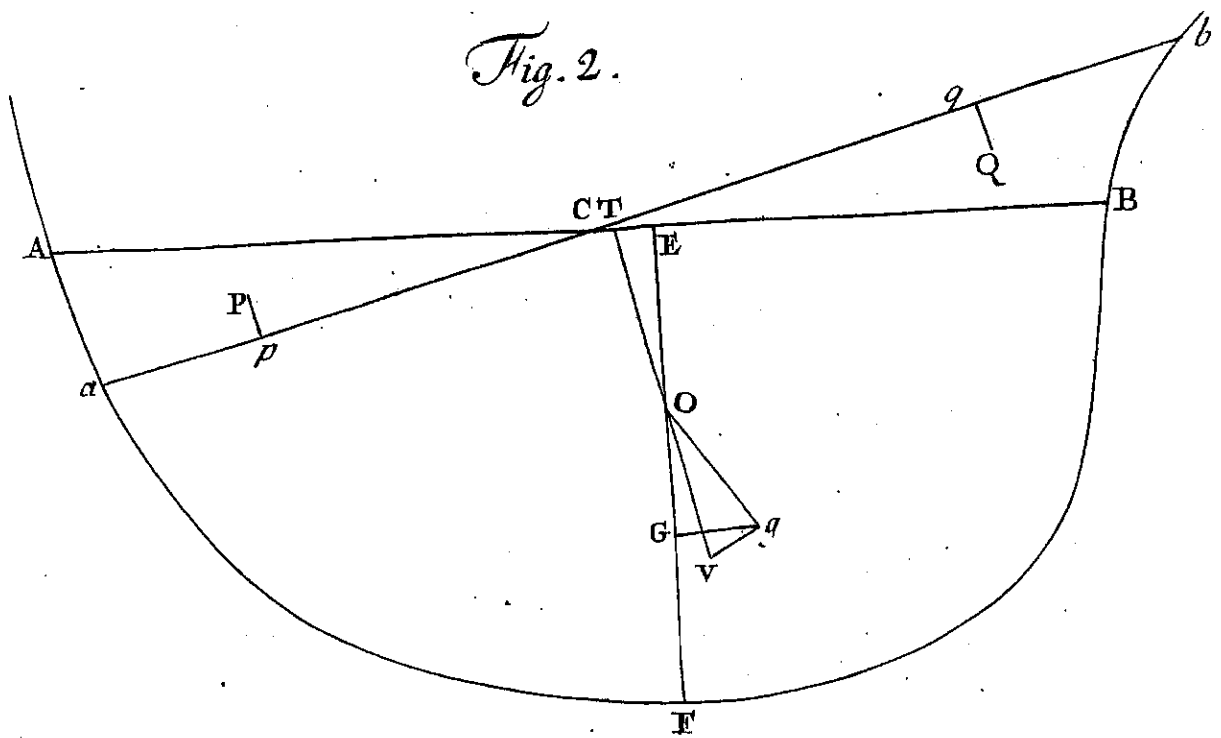
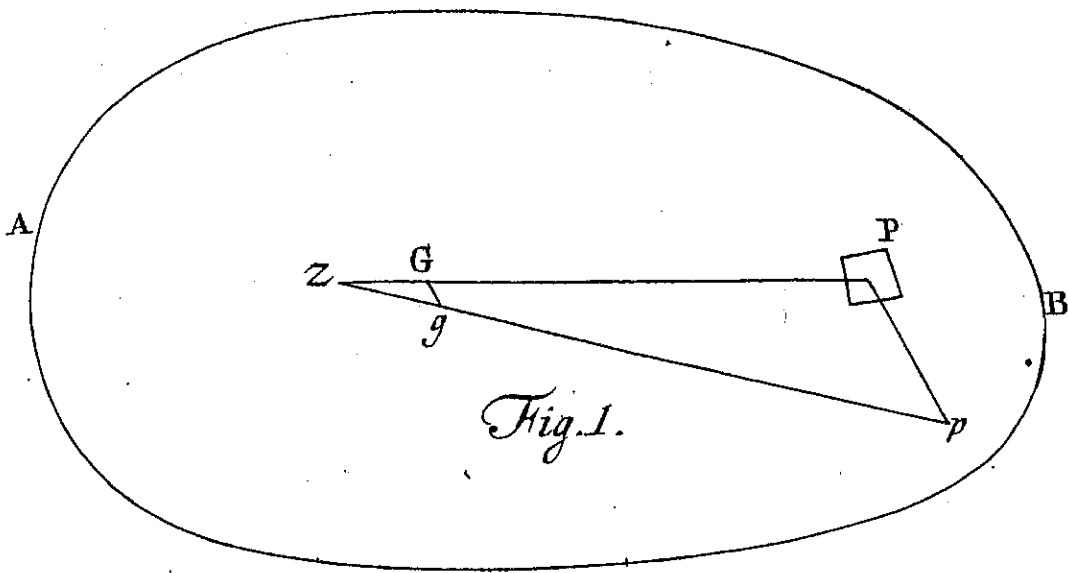


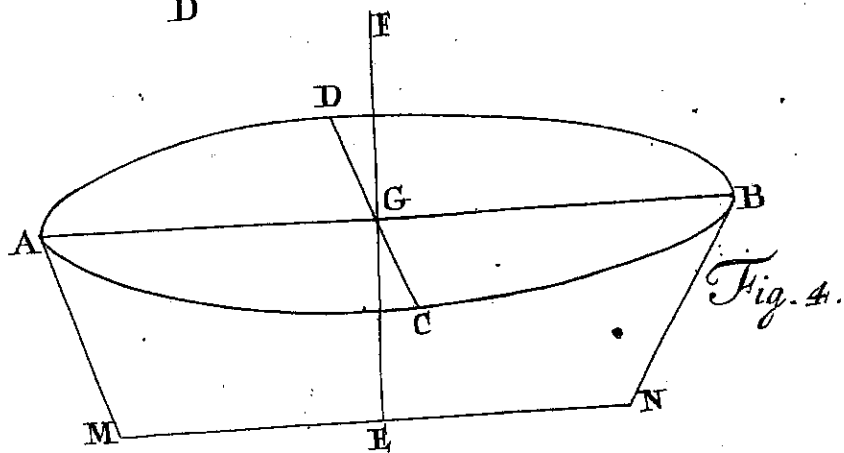
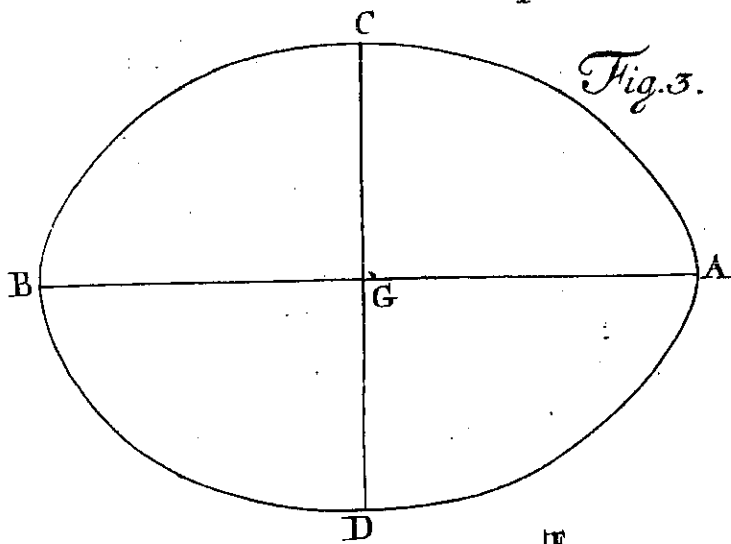
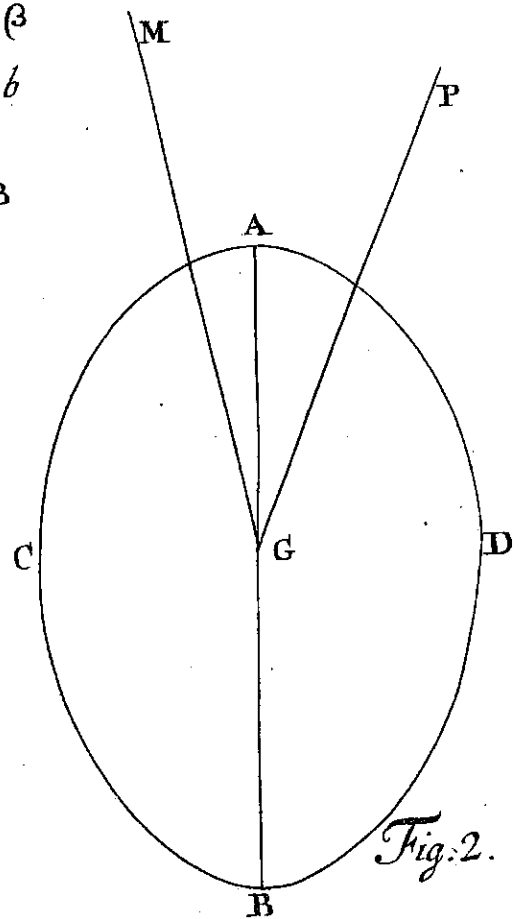
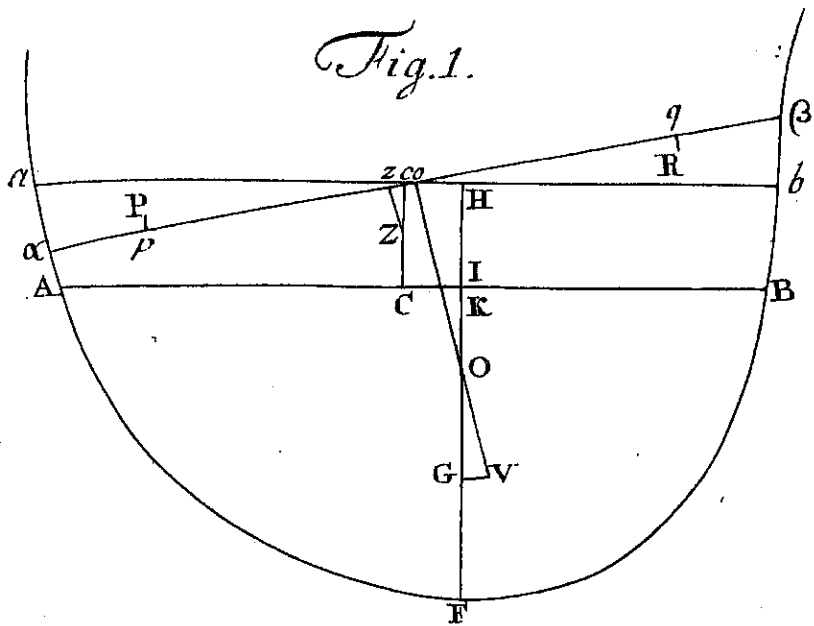
*Fig. 2.*

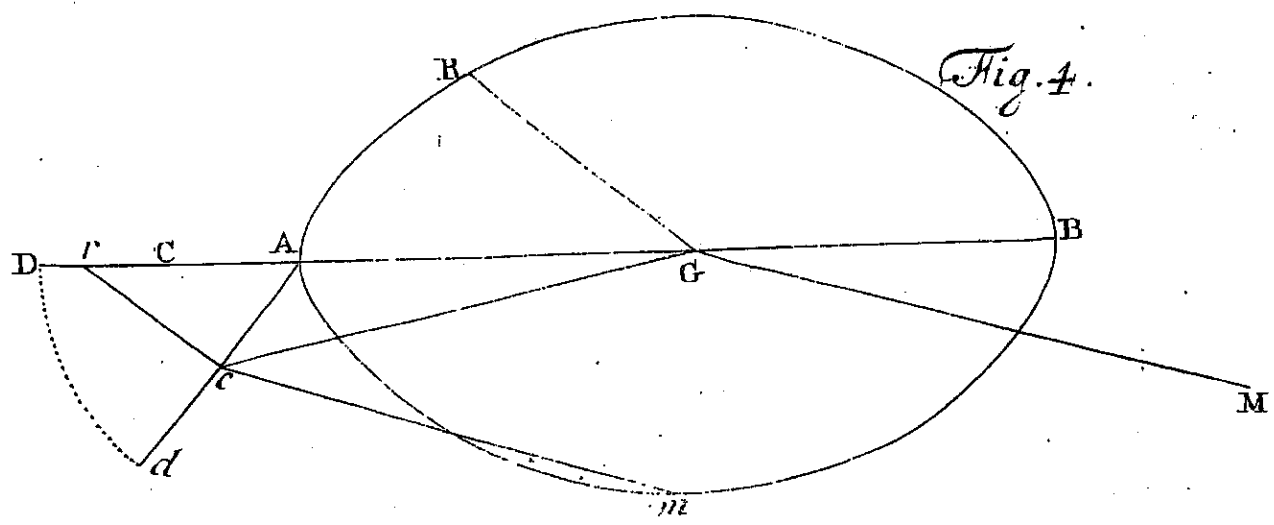
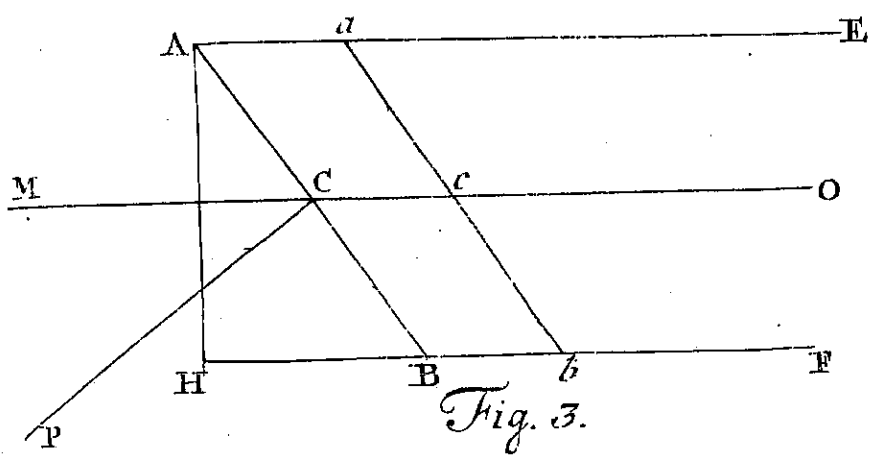
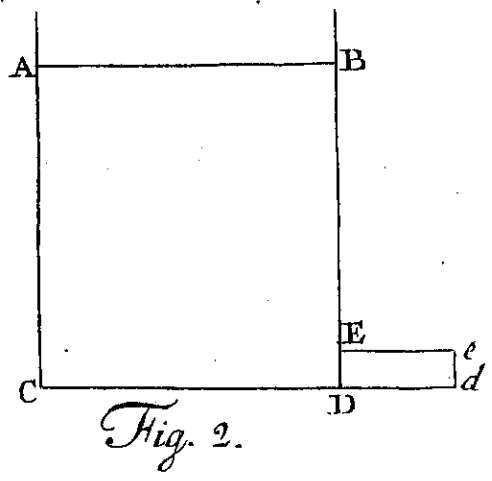
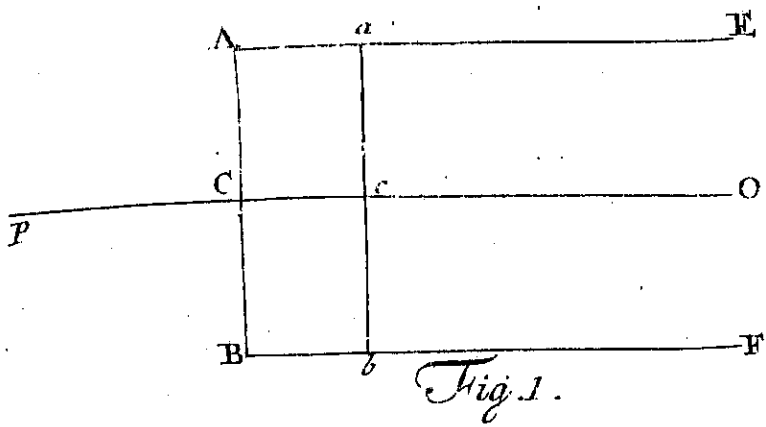


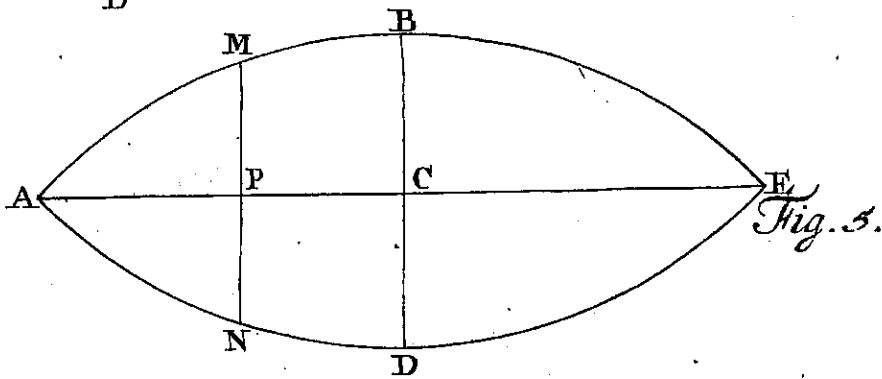
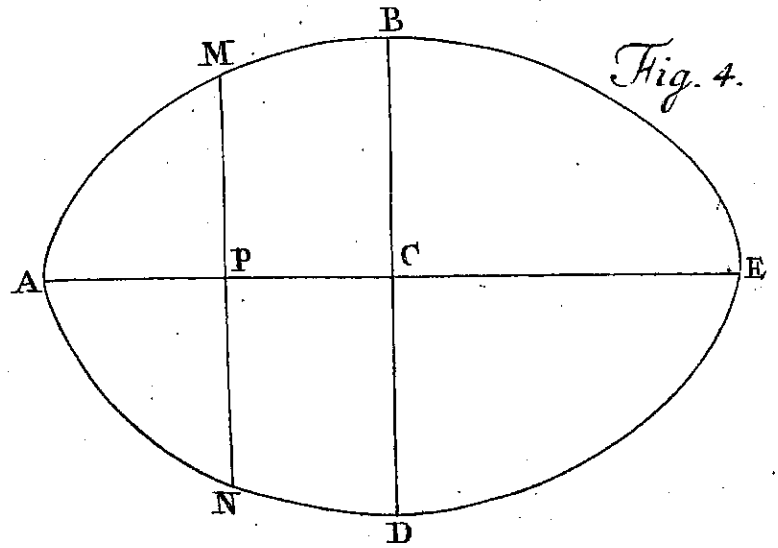
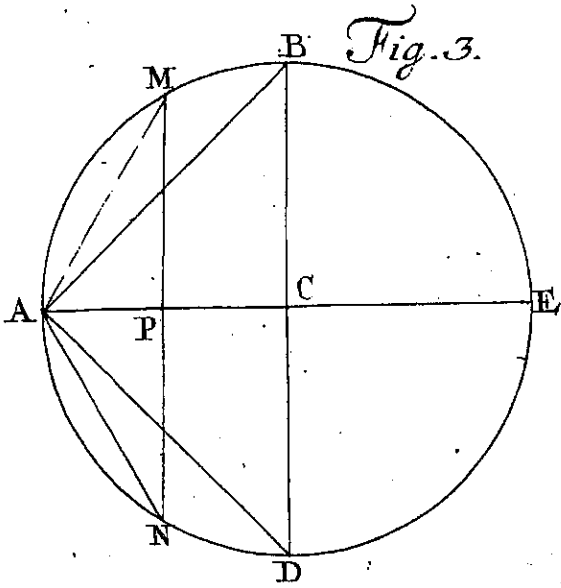
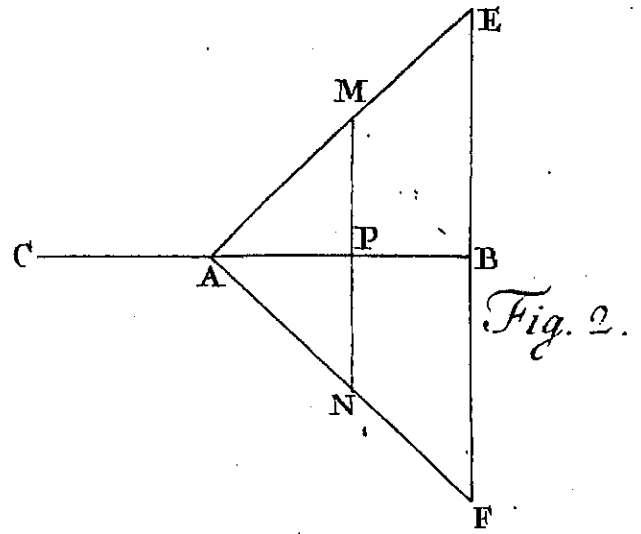
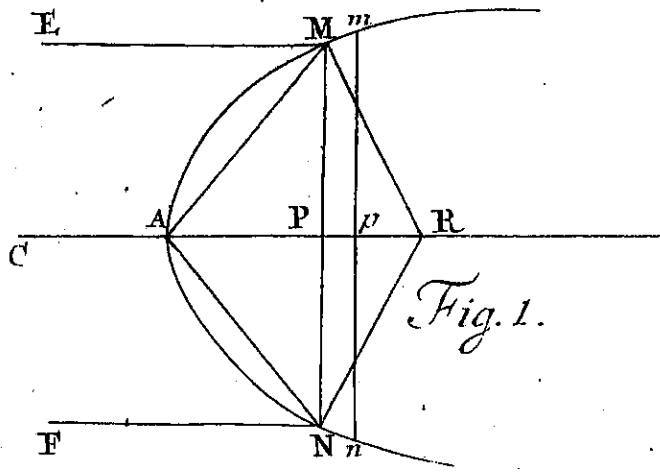
*Fig. 3.*



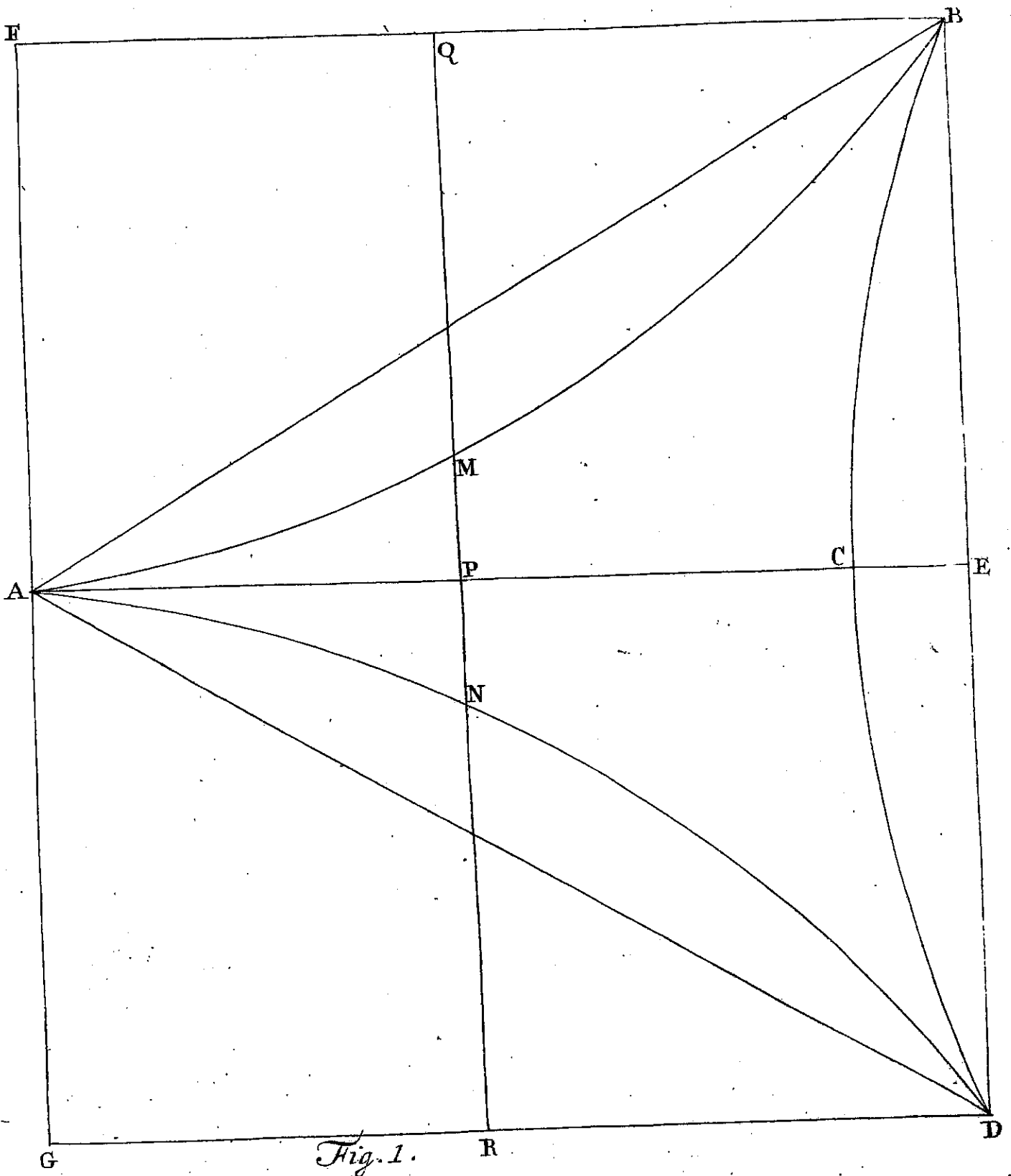






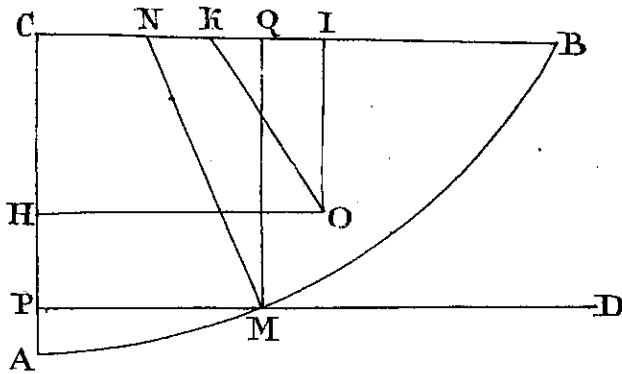




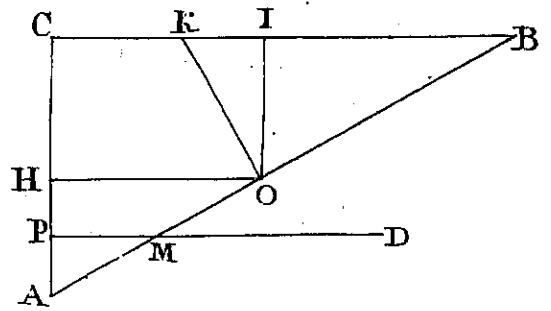


*Fig. 1.*

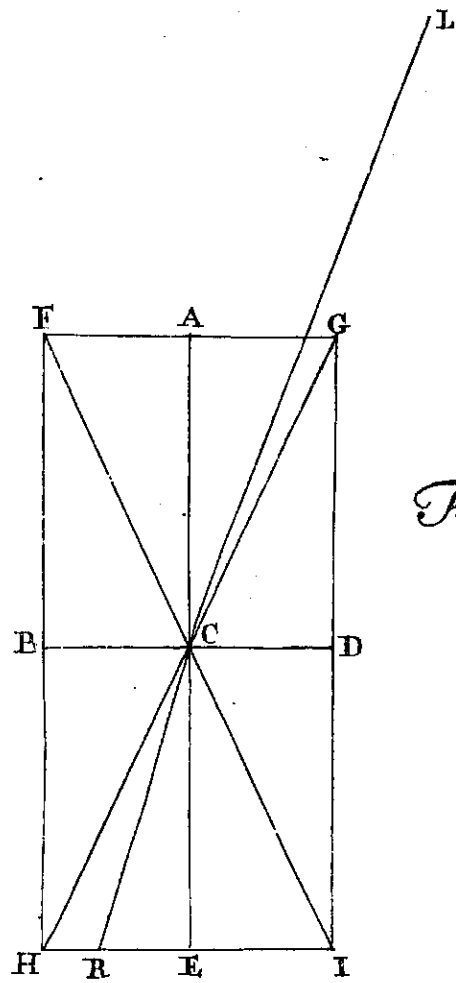
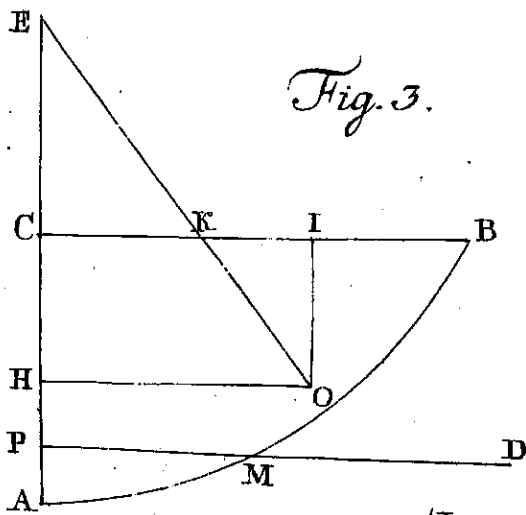
*Fig. 1.*



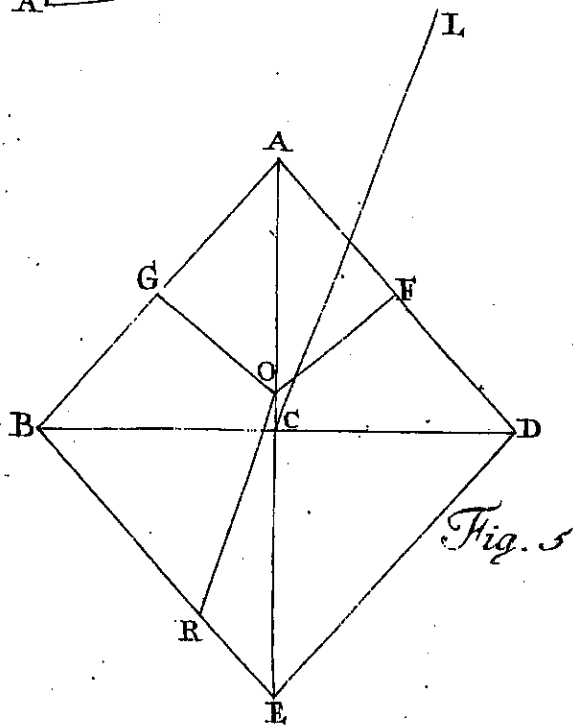
*Fig. 2.*



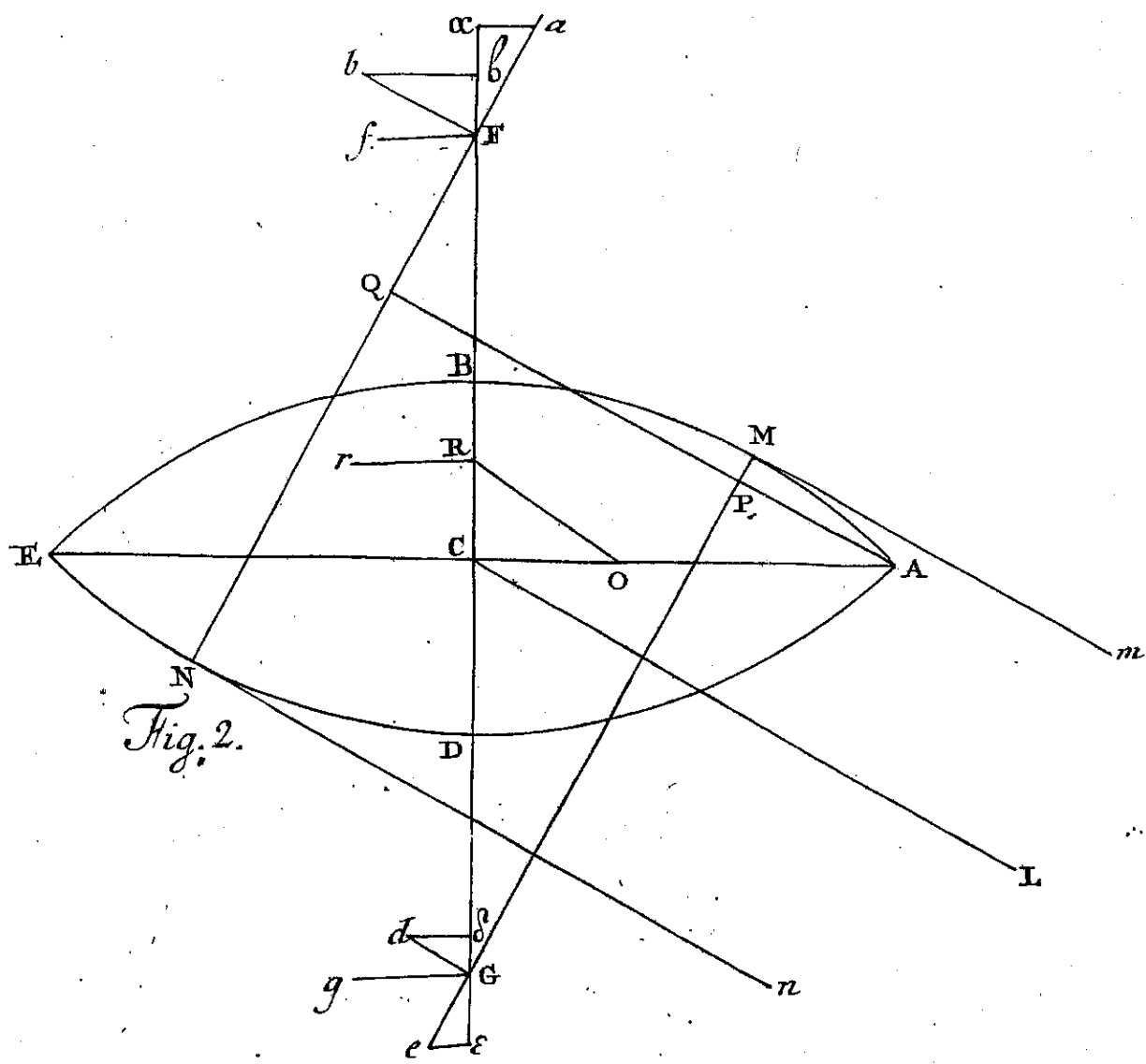
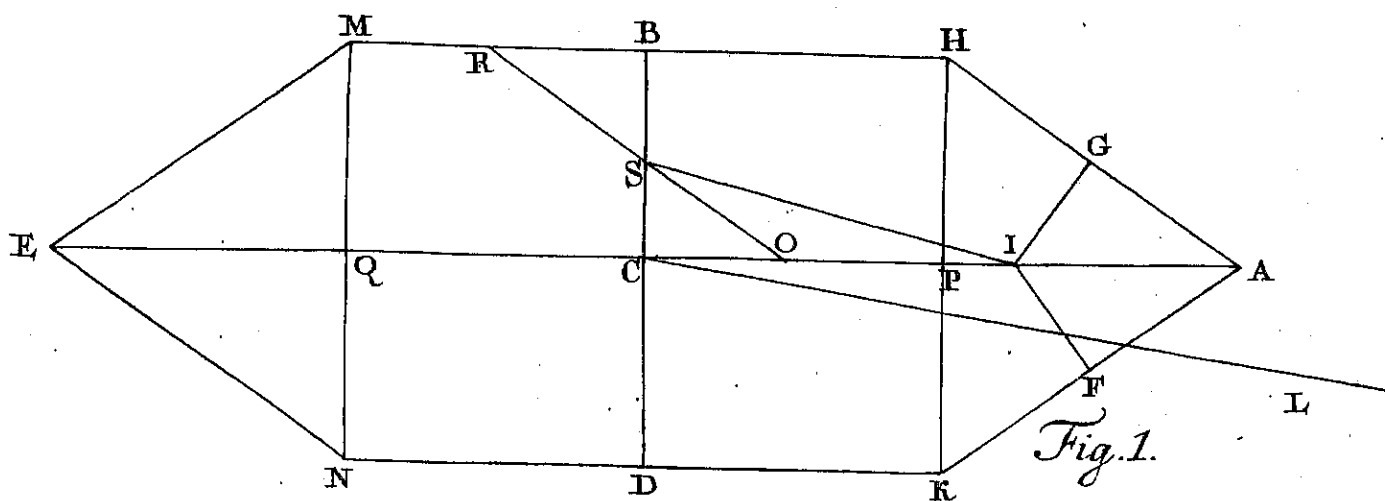
*Fig. 3.*

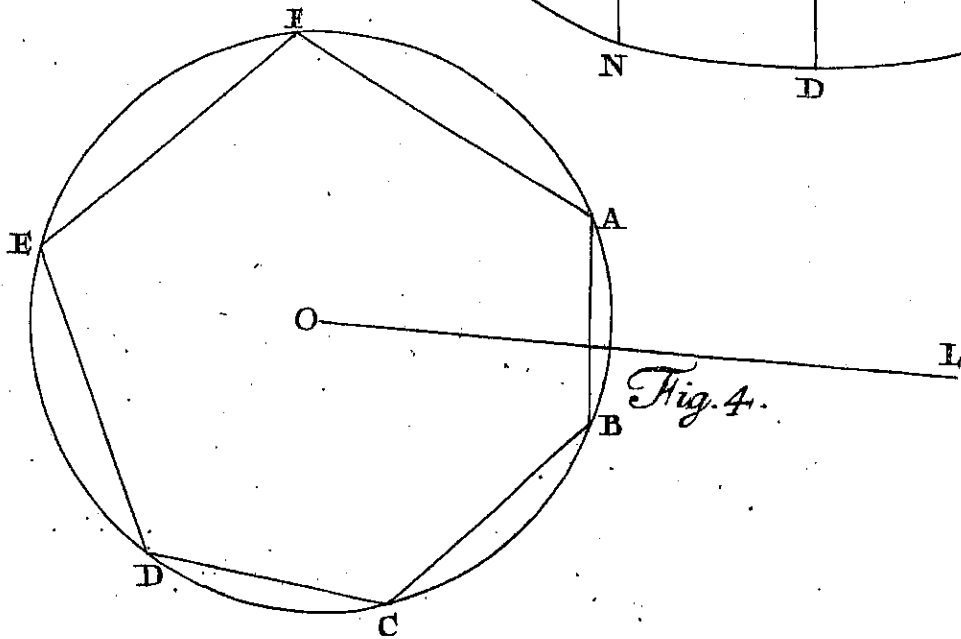
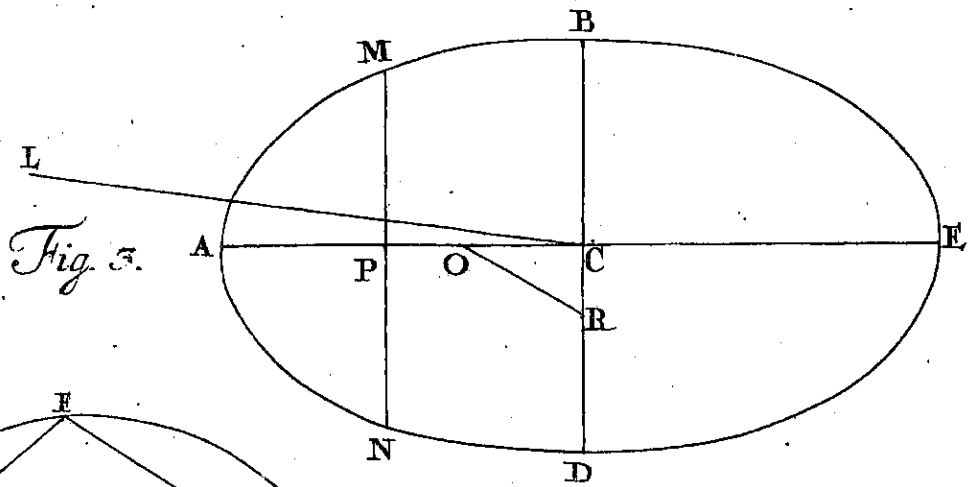
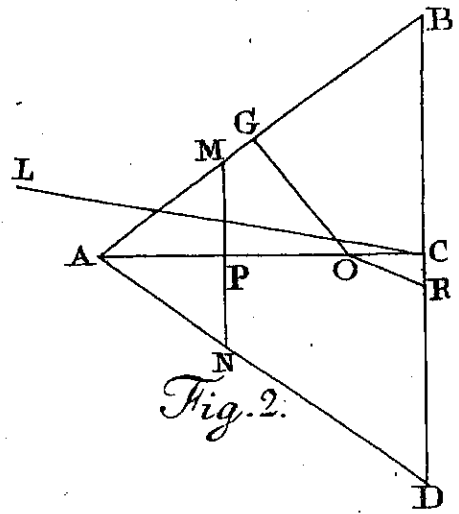
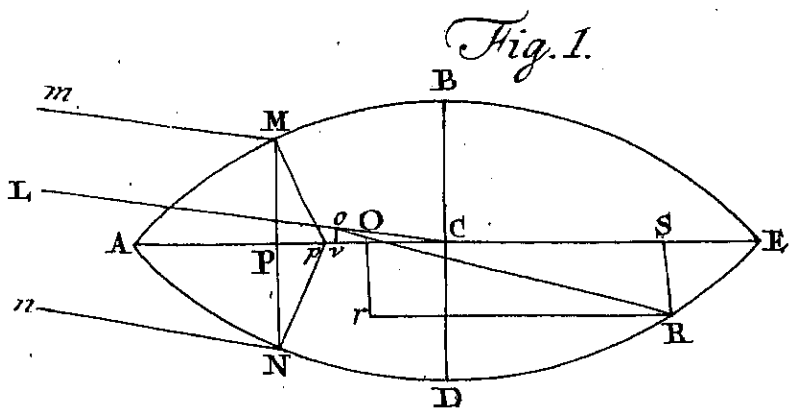


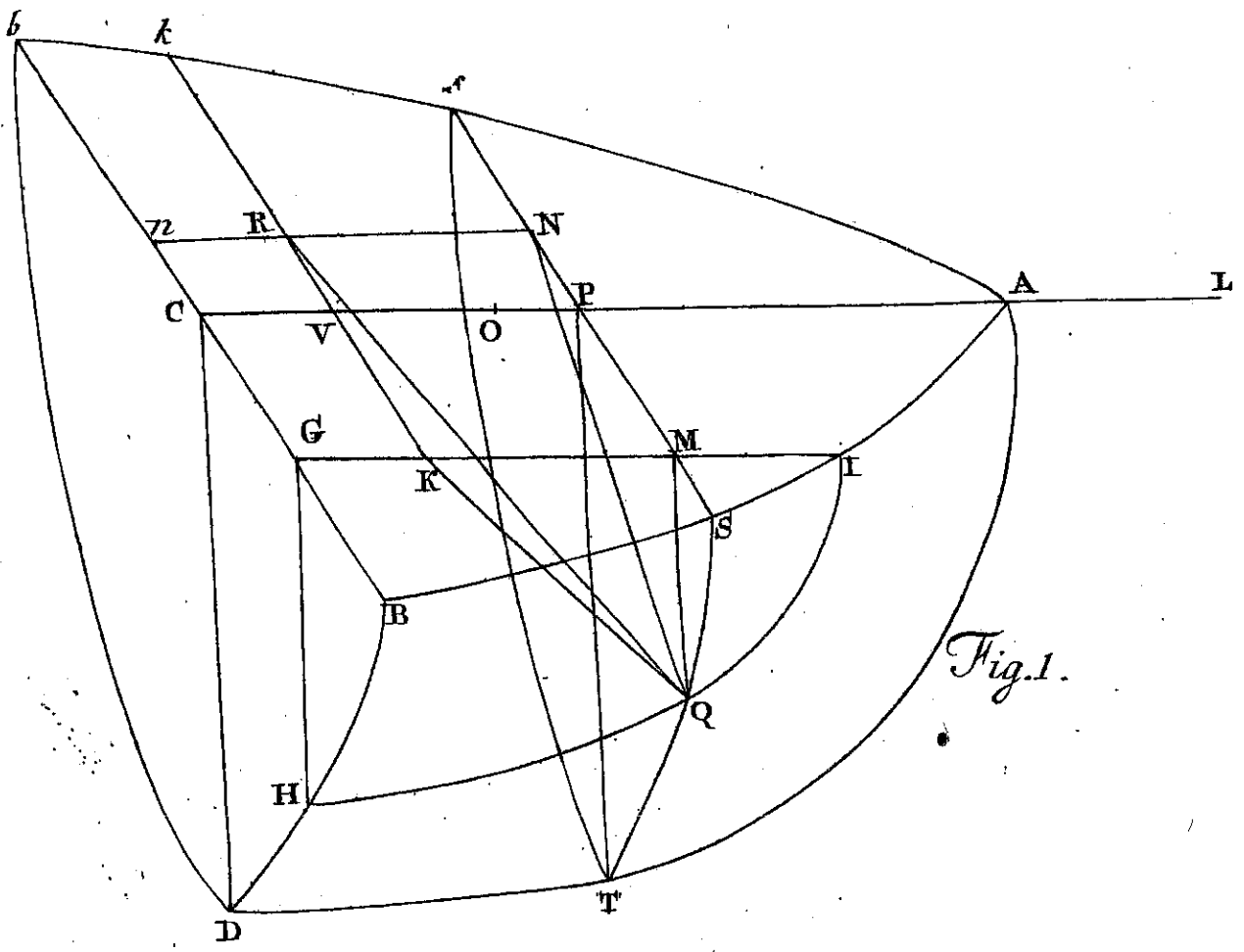
*Fig. 4.*



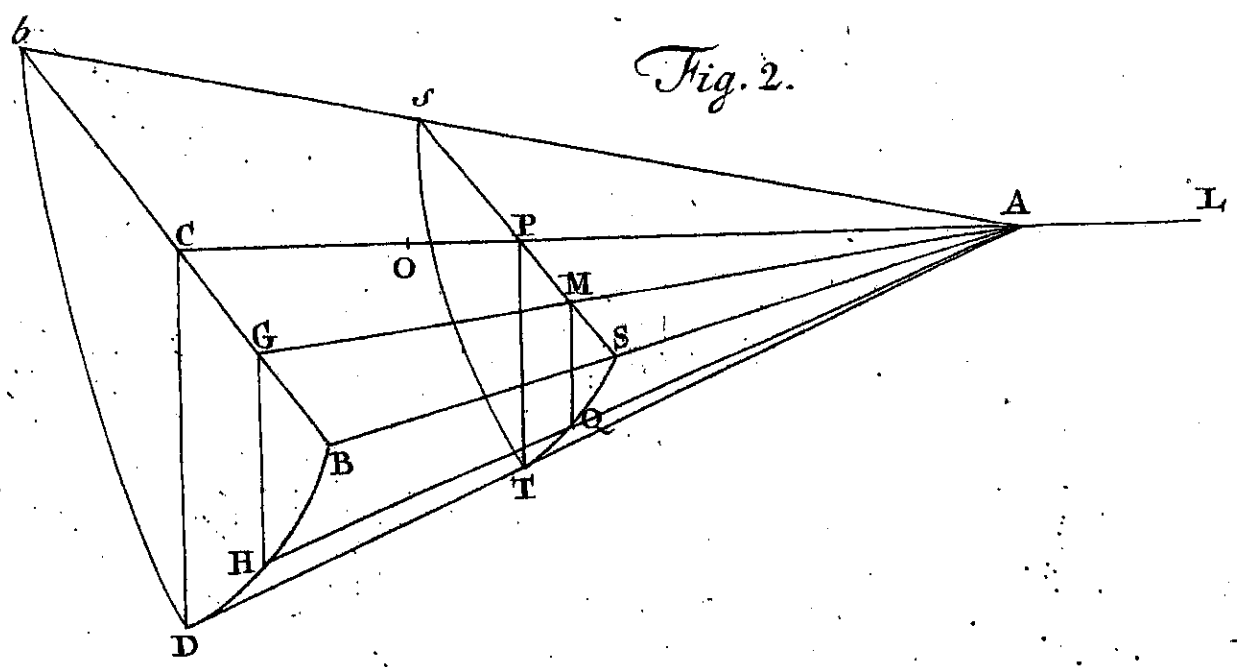
*Fig. 5.*



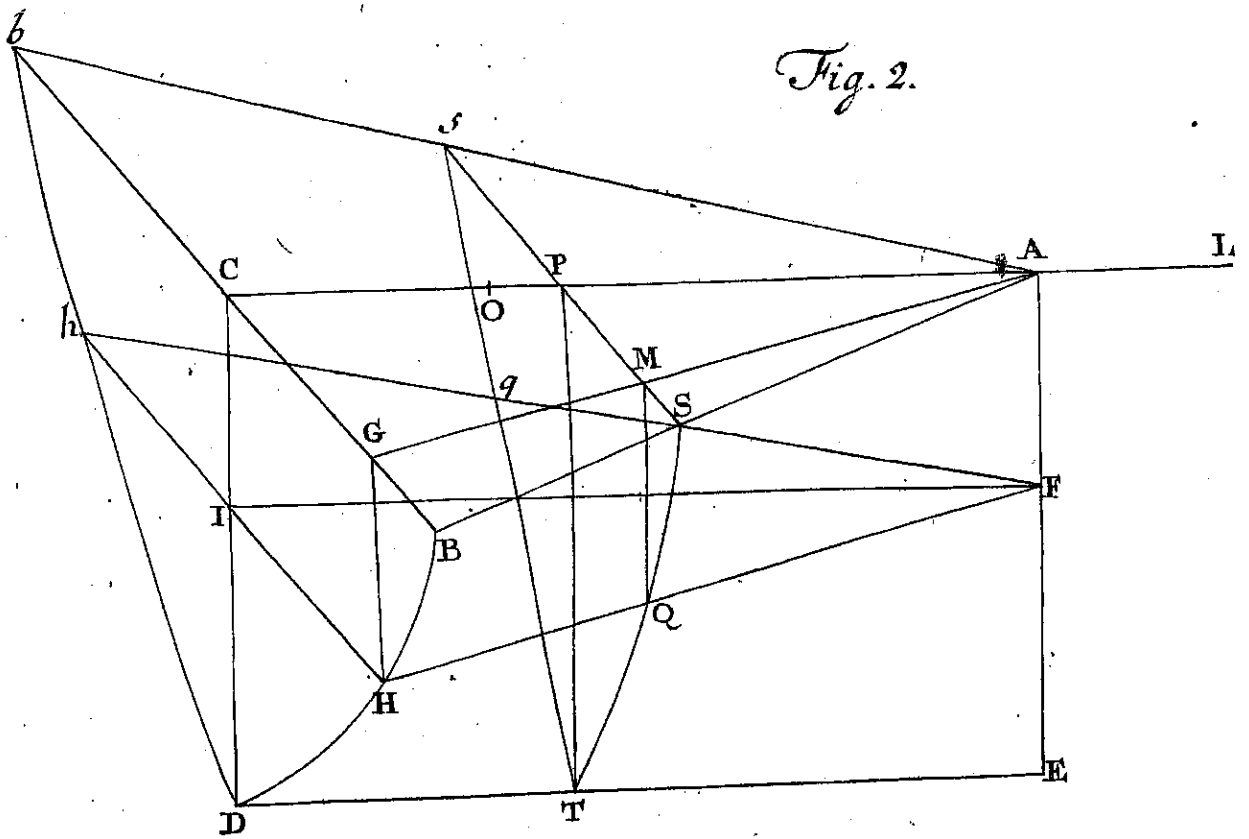
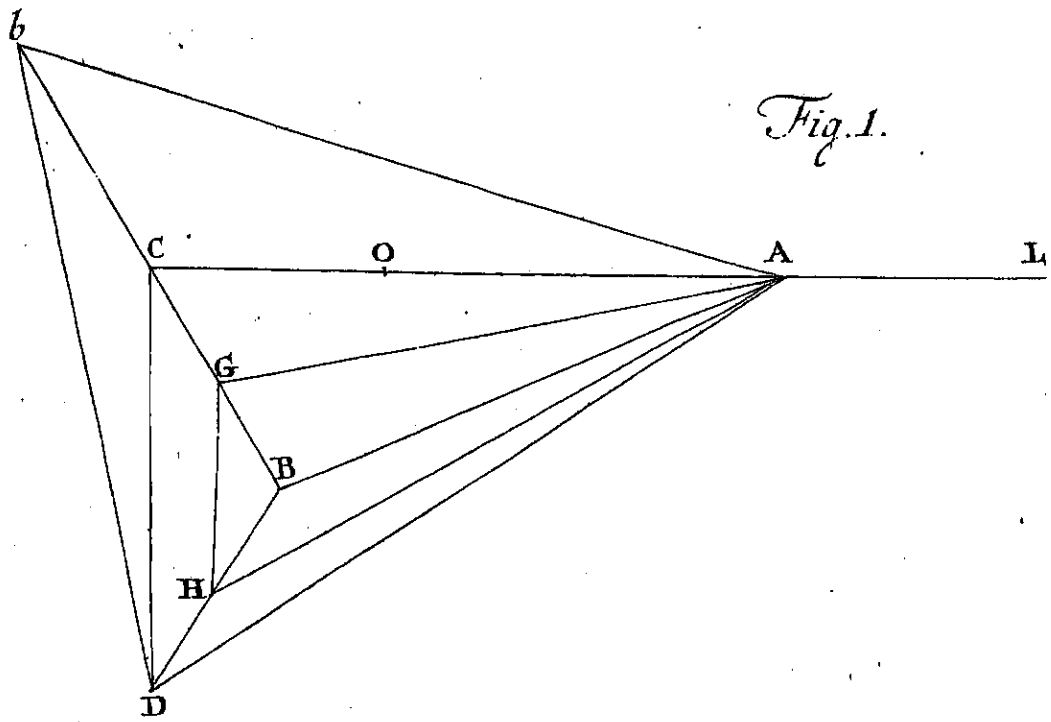


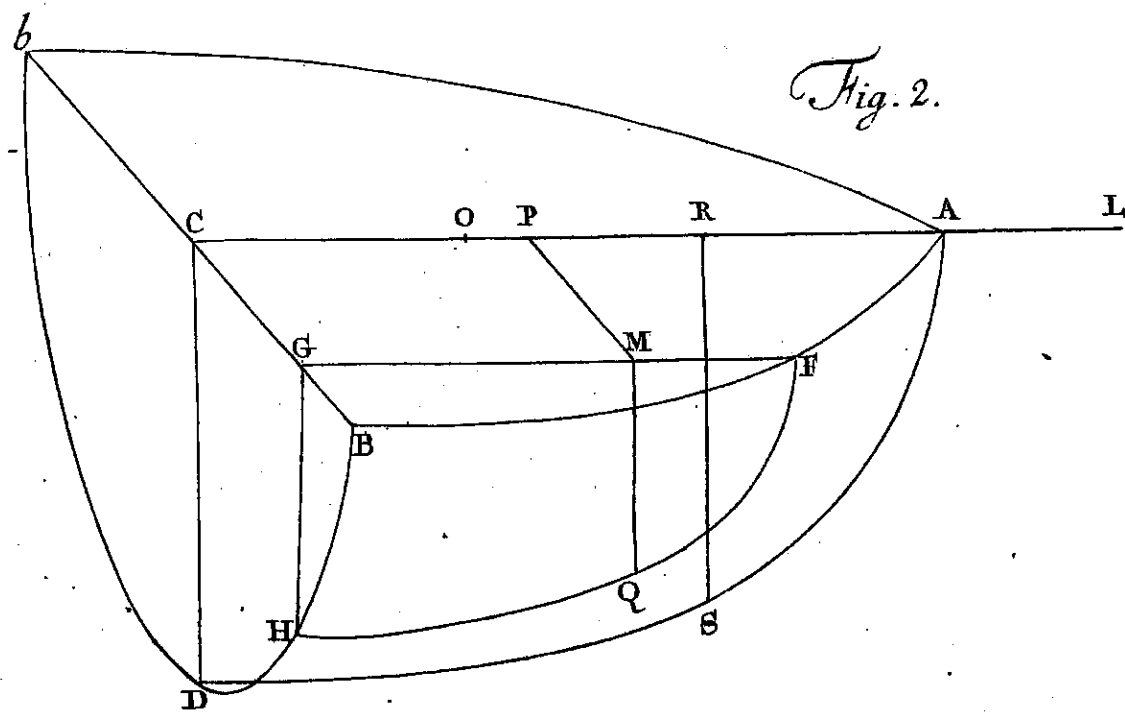
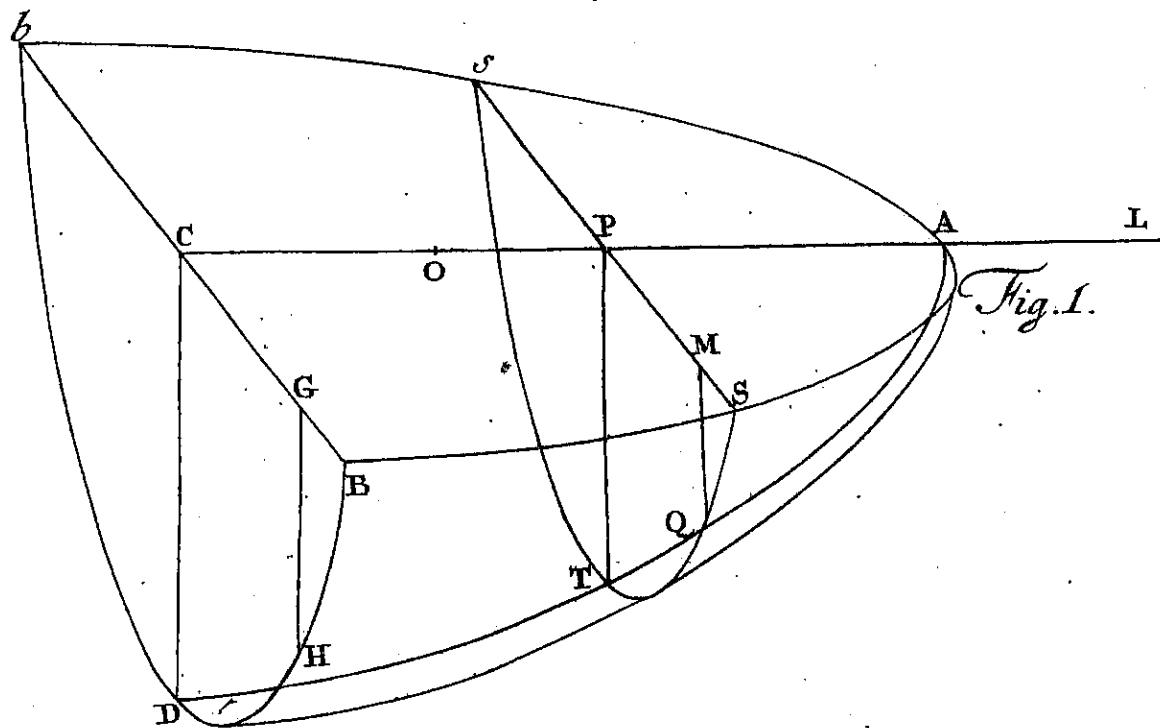


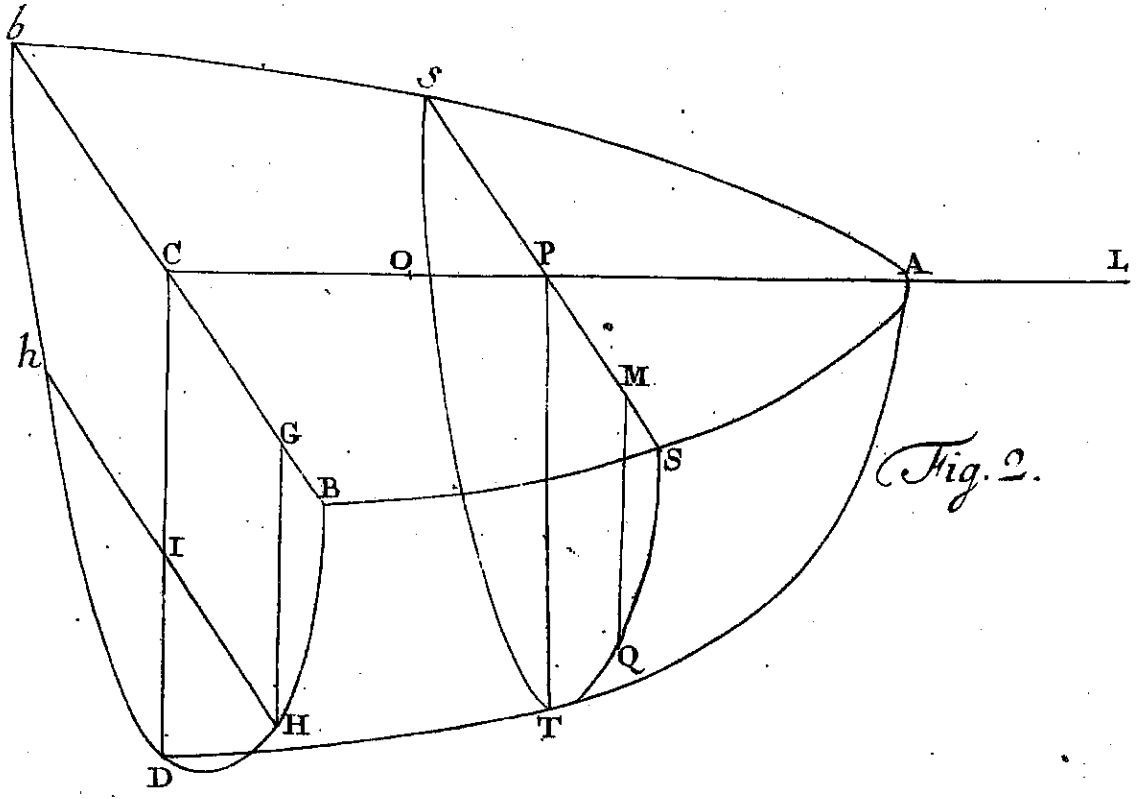
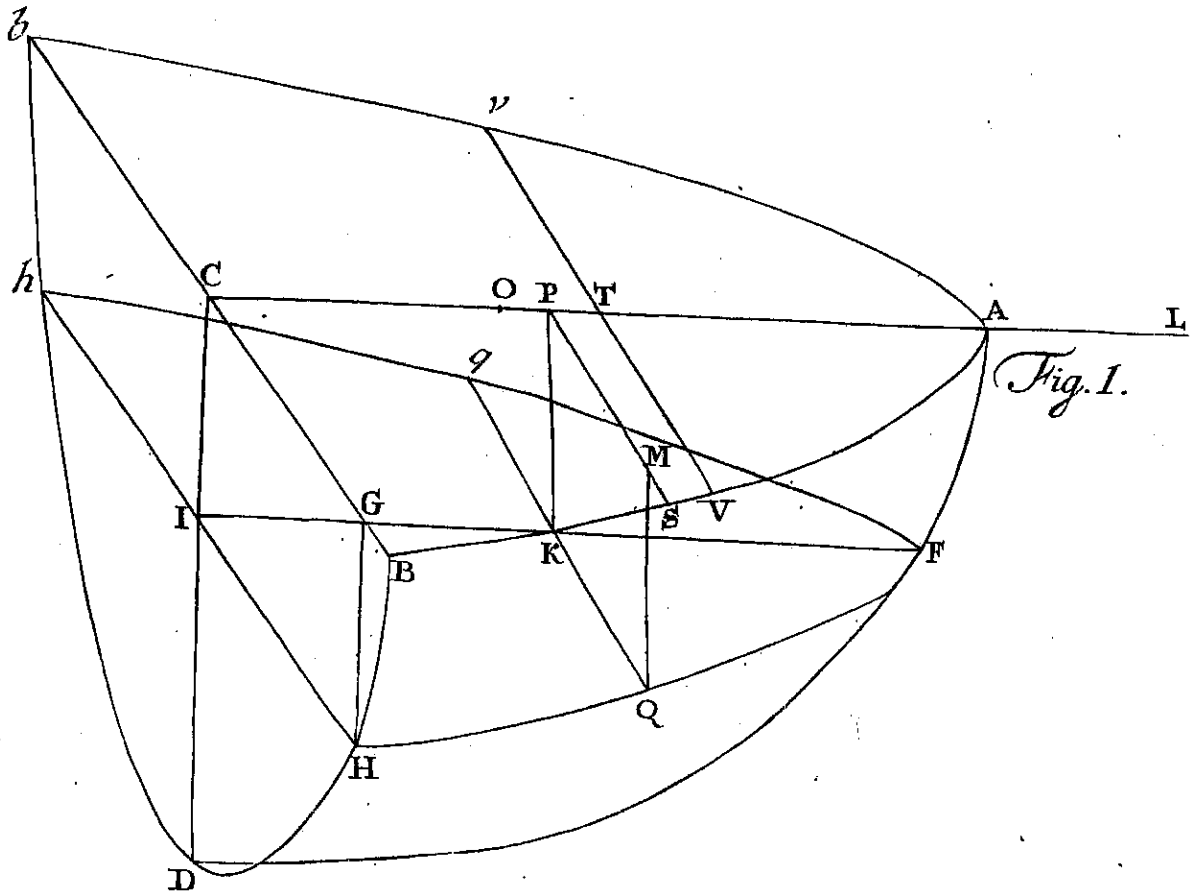
*Fig. 1.*



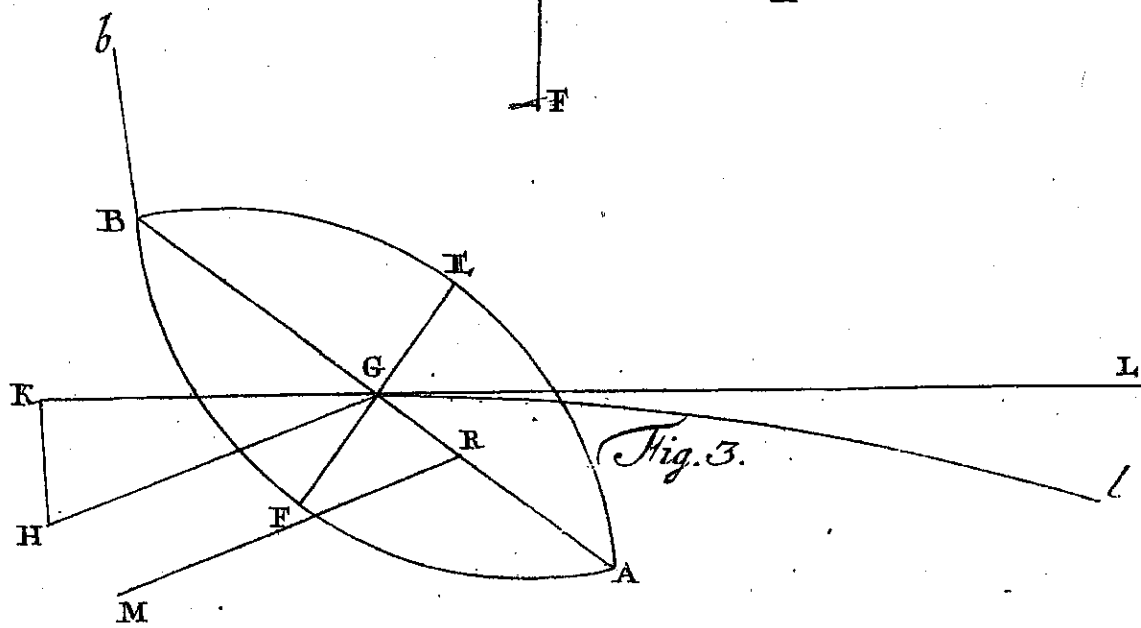
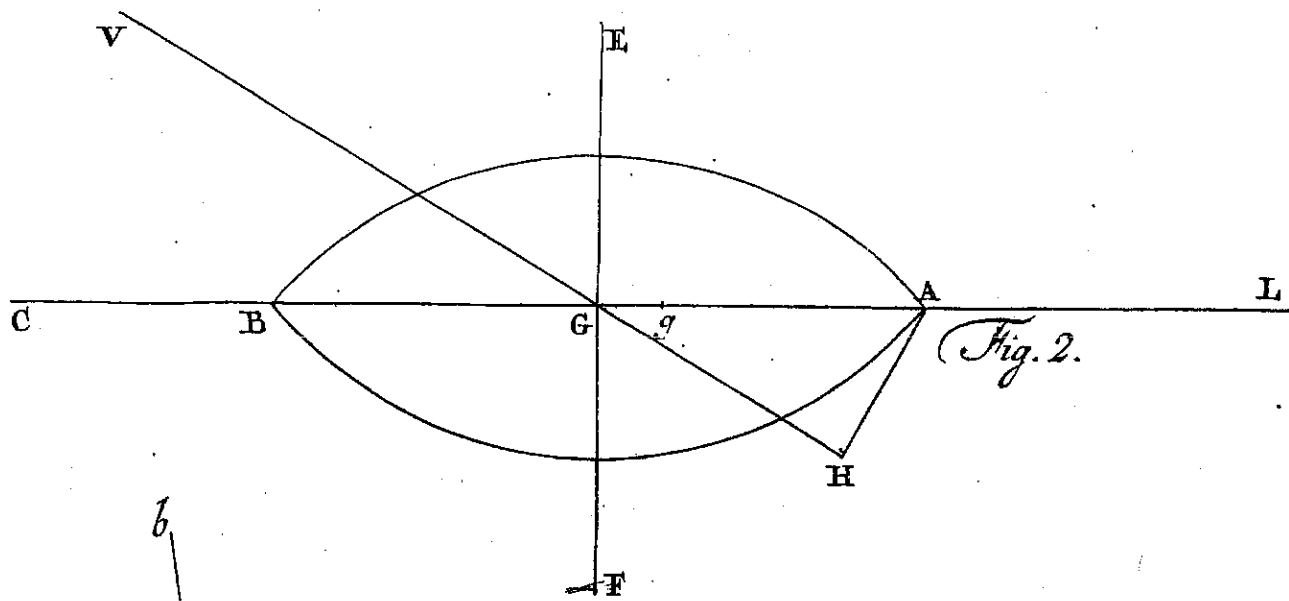
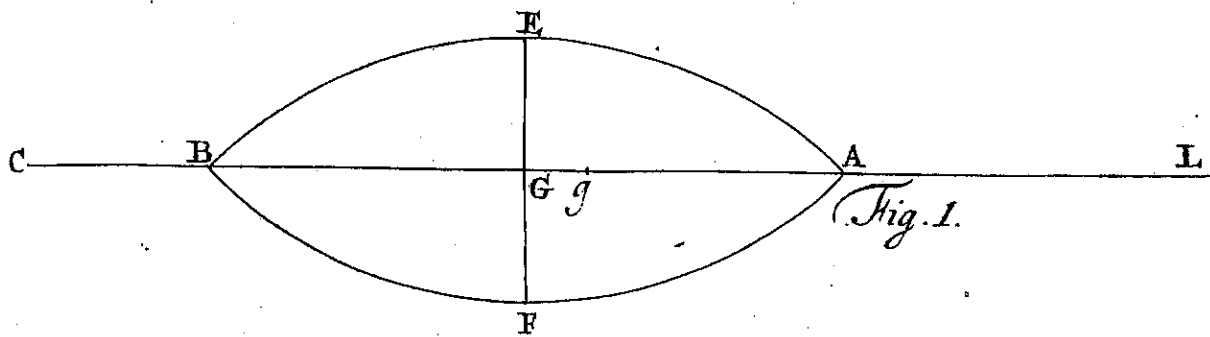
*Fig. 2.*

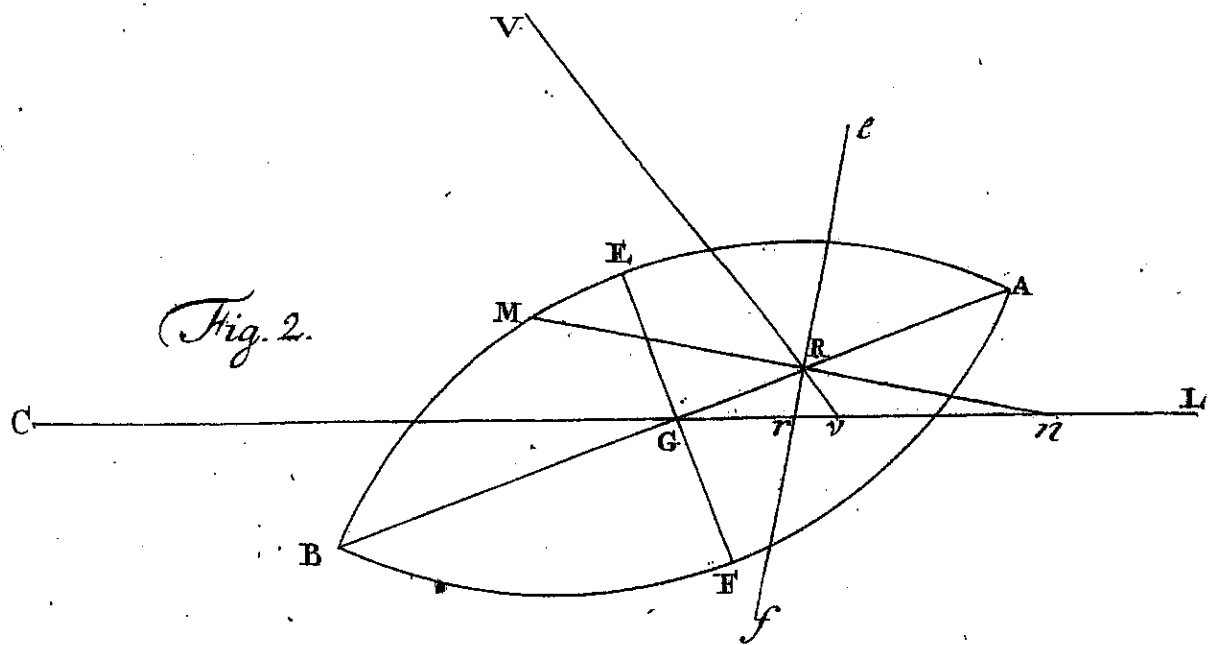
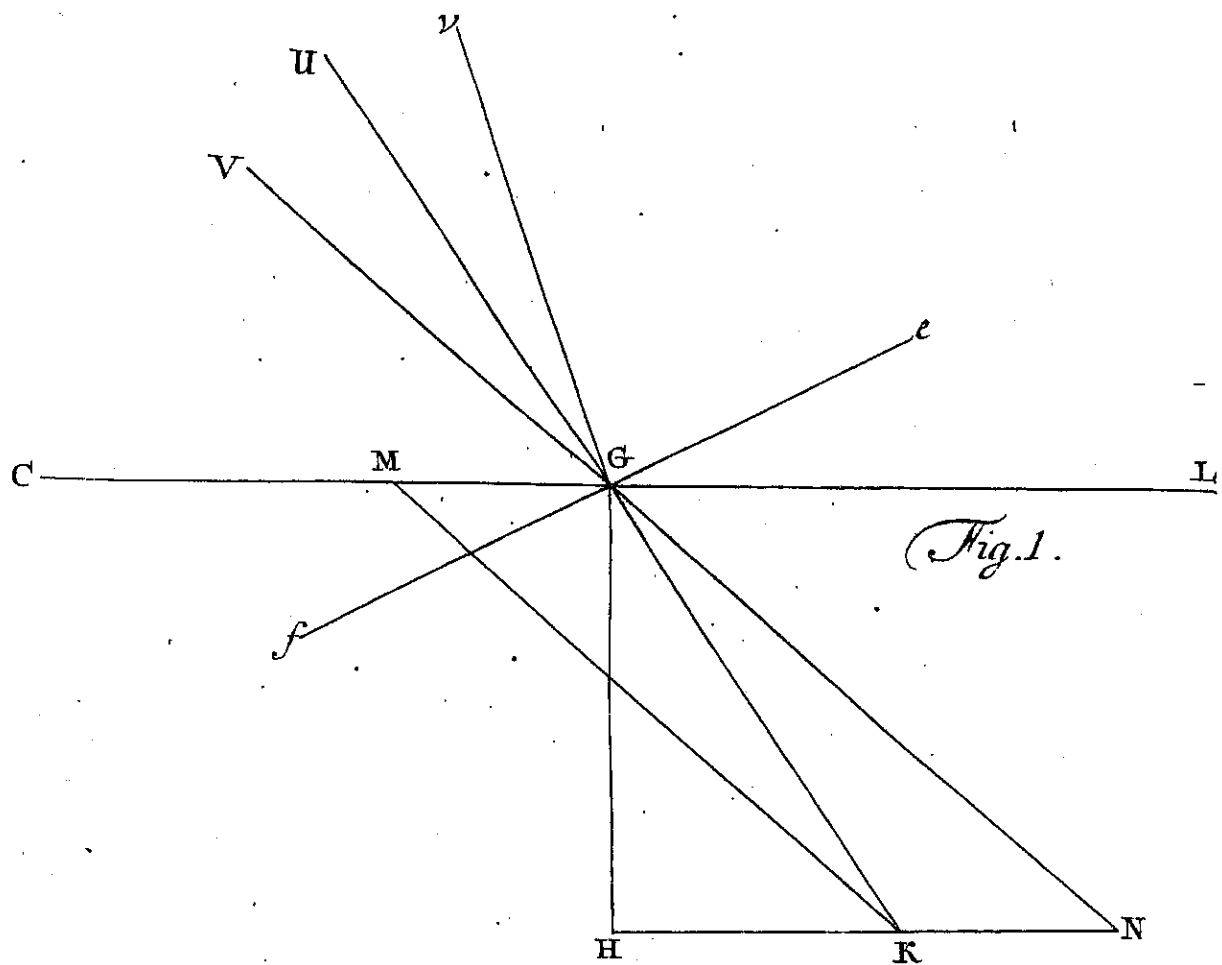


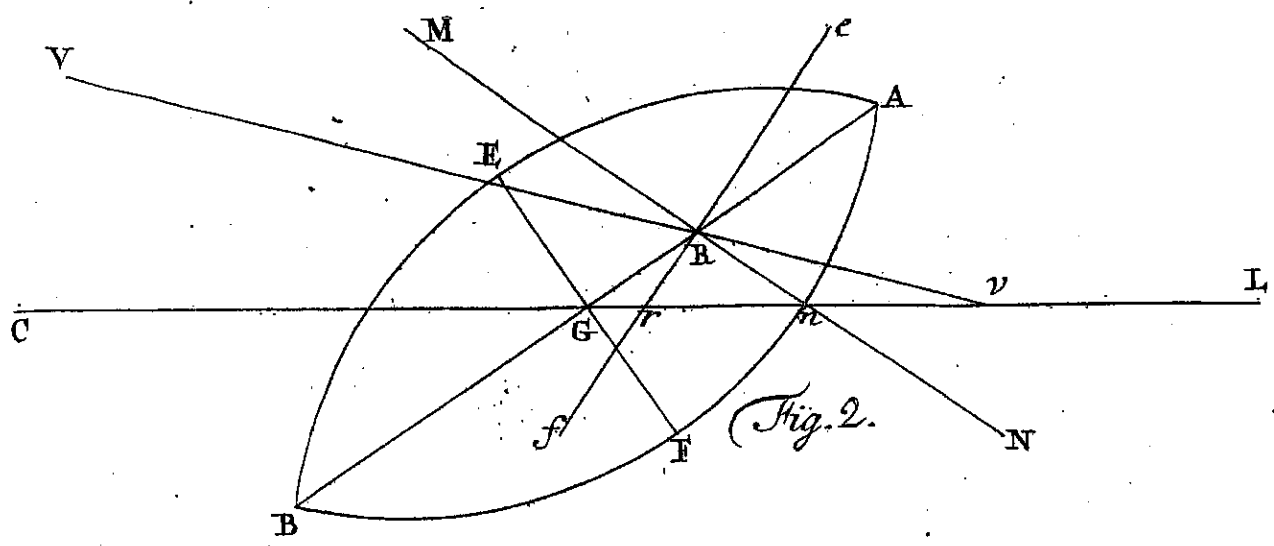
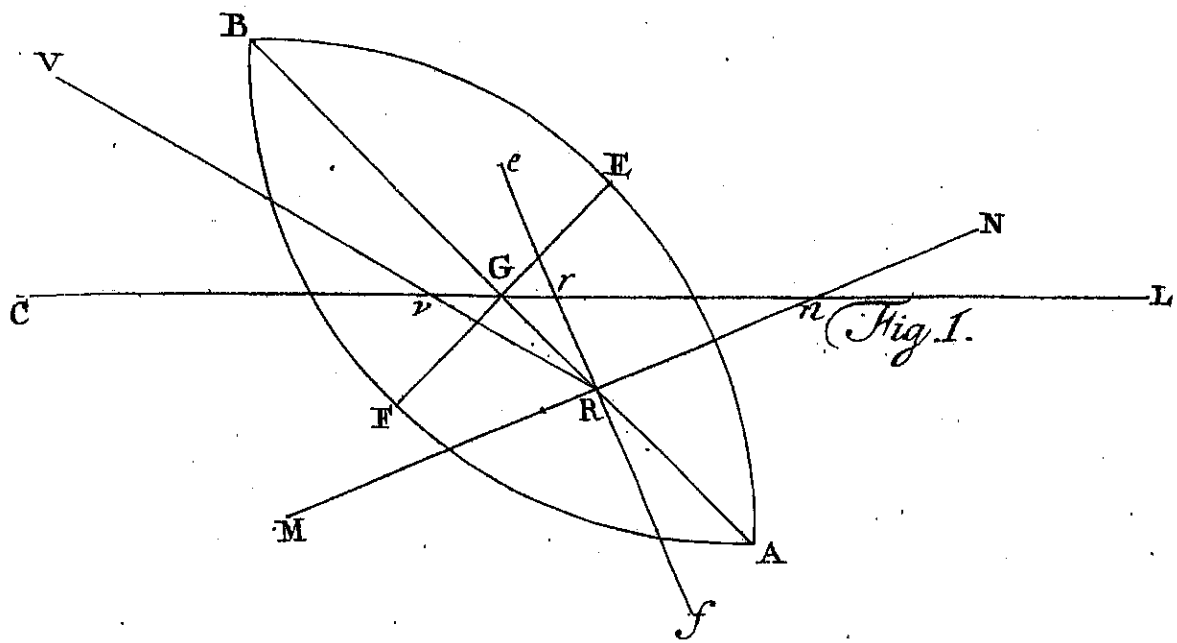


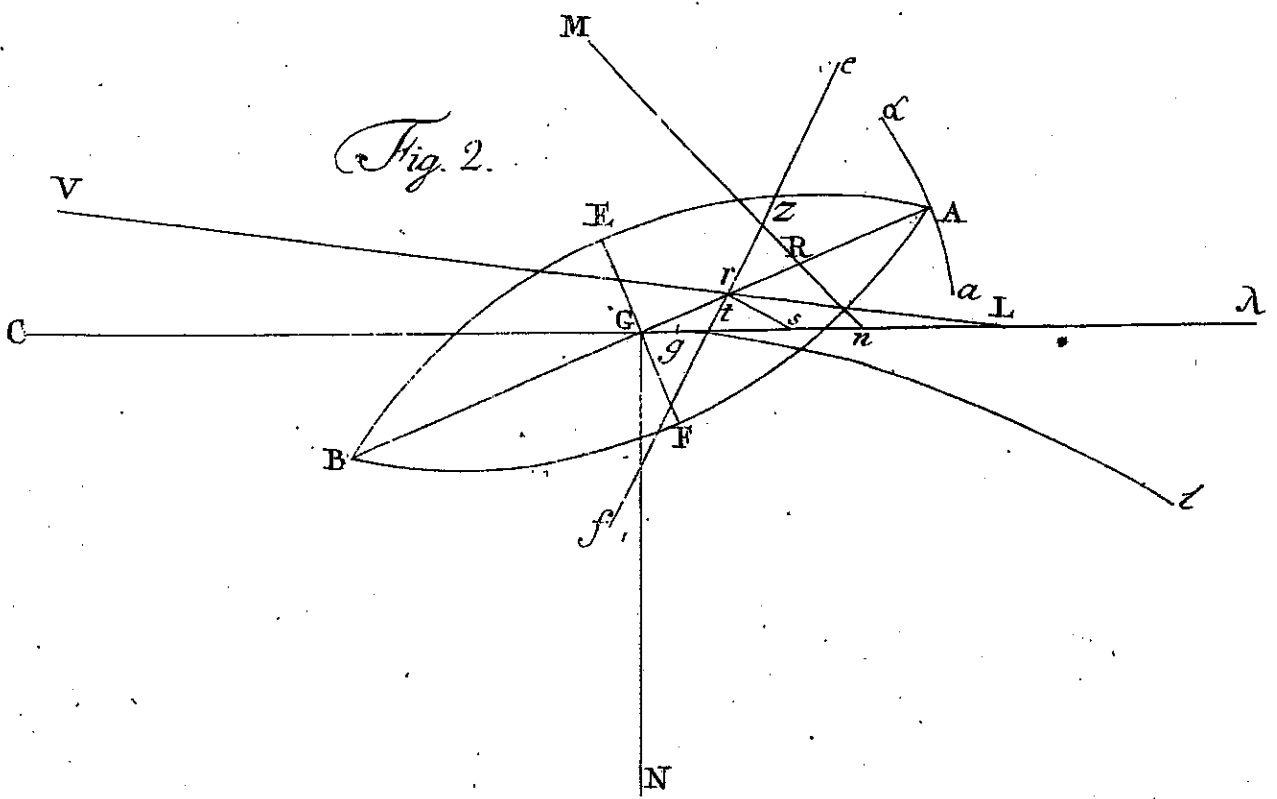
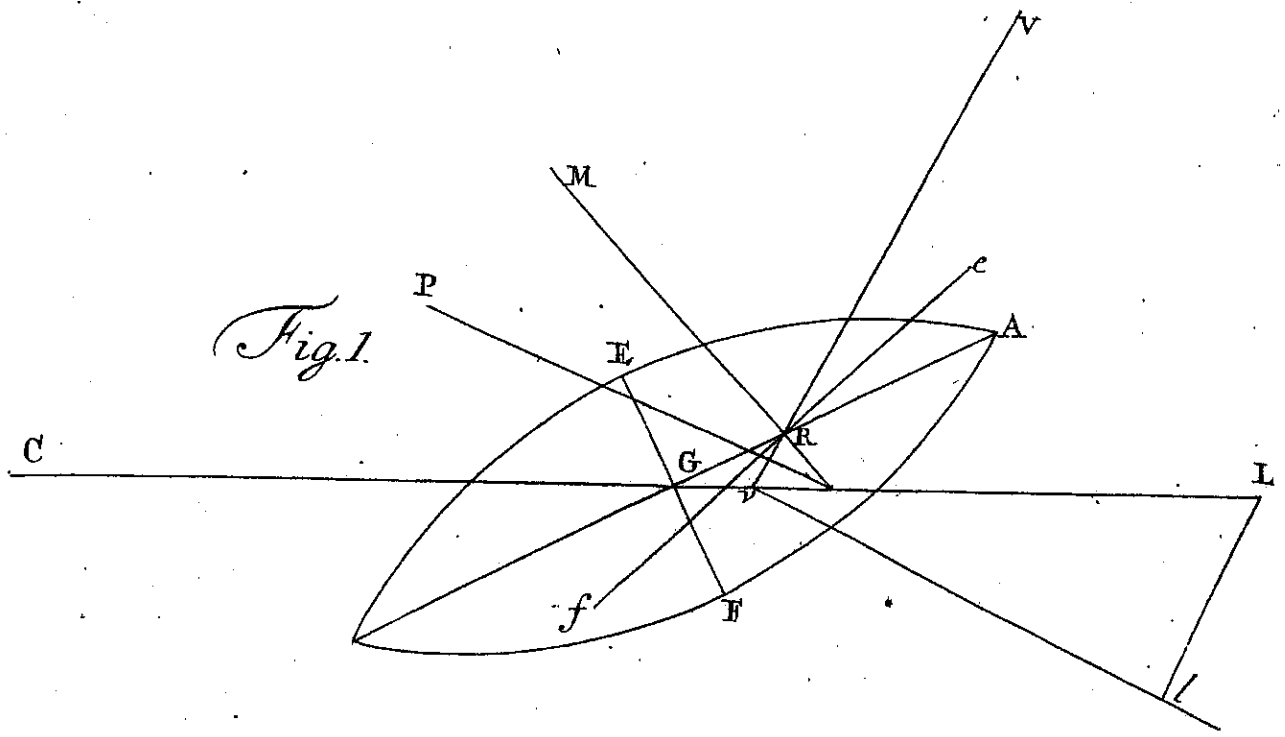


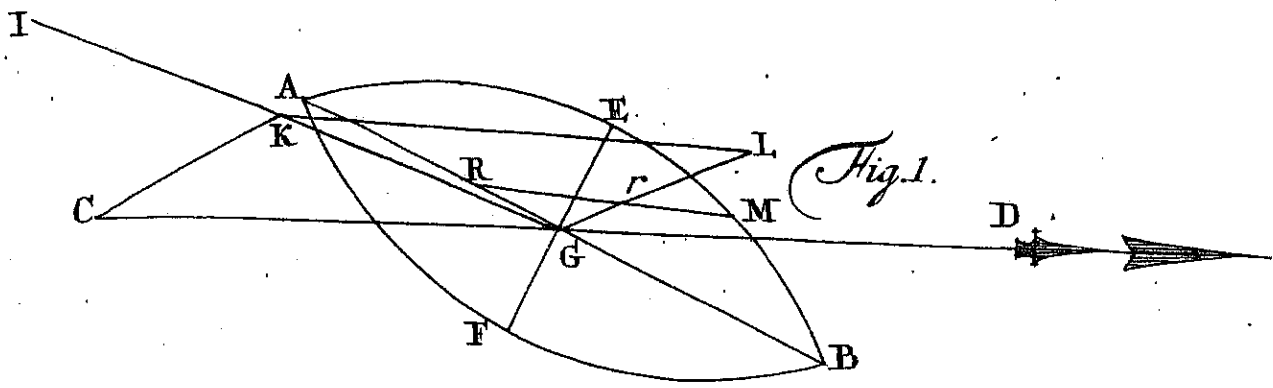




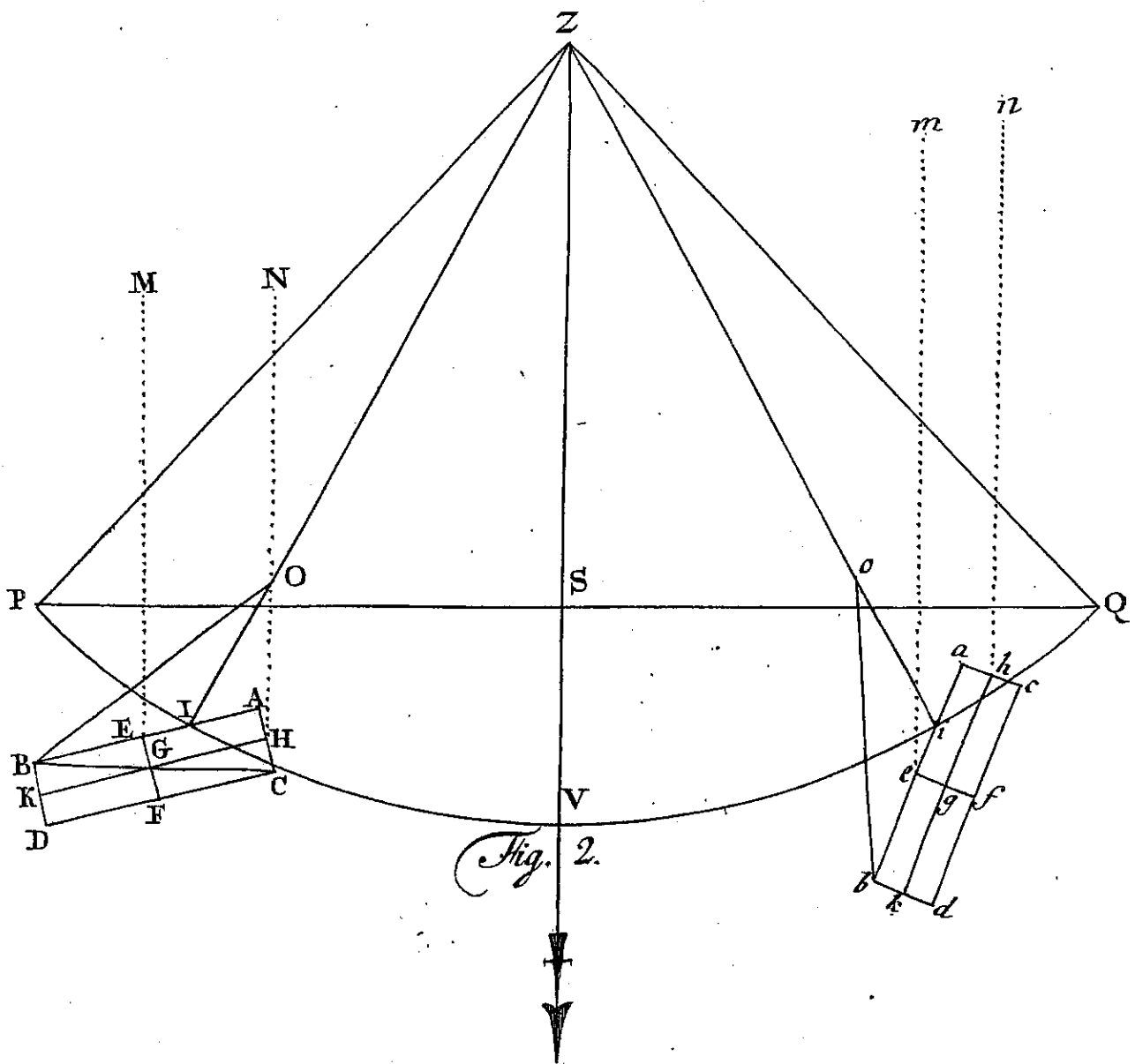




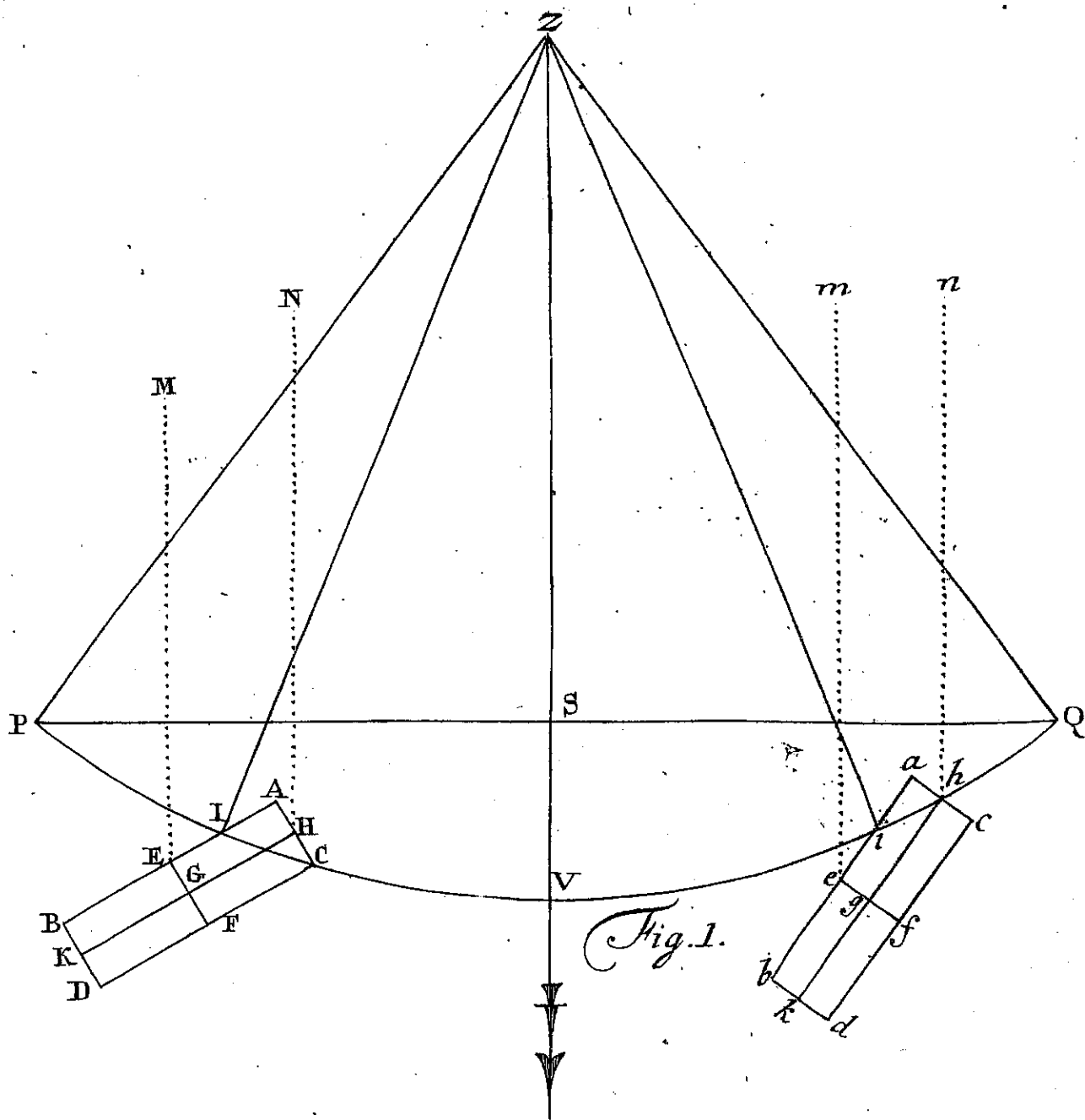




*Fig. 1.*



*Fig. 2.*



*Fig. 1.*