

Index Capitum

- Cap. I. De aequilibrio corporum aquae insidentium a §. 1.
ad §. 109
- Cap. II. De corporum aquae insidentium restitutione in aequilibrium a §. 110. ad 203
- Cap. III. De stabilitate qua corpora aquae insidentia in situ aequilibrum persistunt a §. 204. ad 399.
- Cap. IV. De effectu virium corpora aquae insidentia sollicitantium a §. 400. ad 464.
- Cap. V. De resistentia quam figurae planae in aqua motae patiuntur a §. 465. ad 611.
- Cap. VI. De resistentia, quam corpora quaecunque in aqua motu directo lata patiuntur a §. 612. ad 761.
- Cap. VII. De motu progressivo corporum aquae innatantium a §. 762. ad 912.

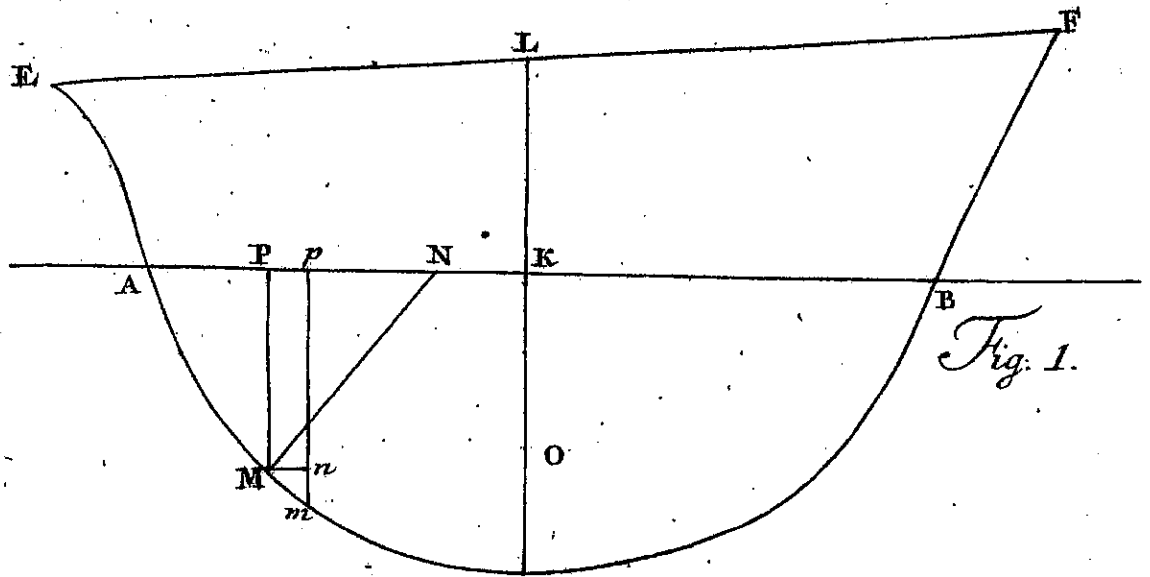

Fig. 1.

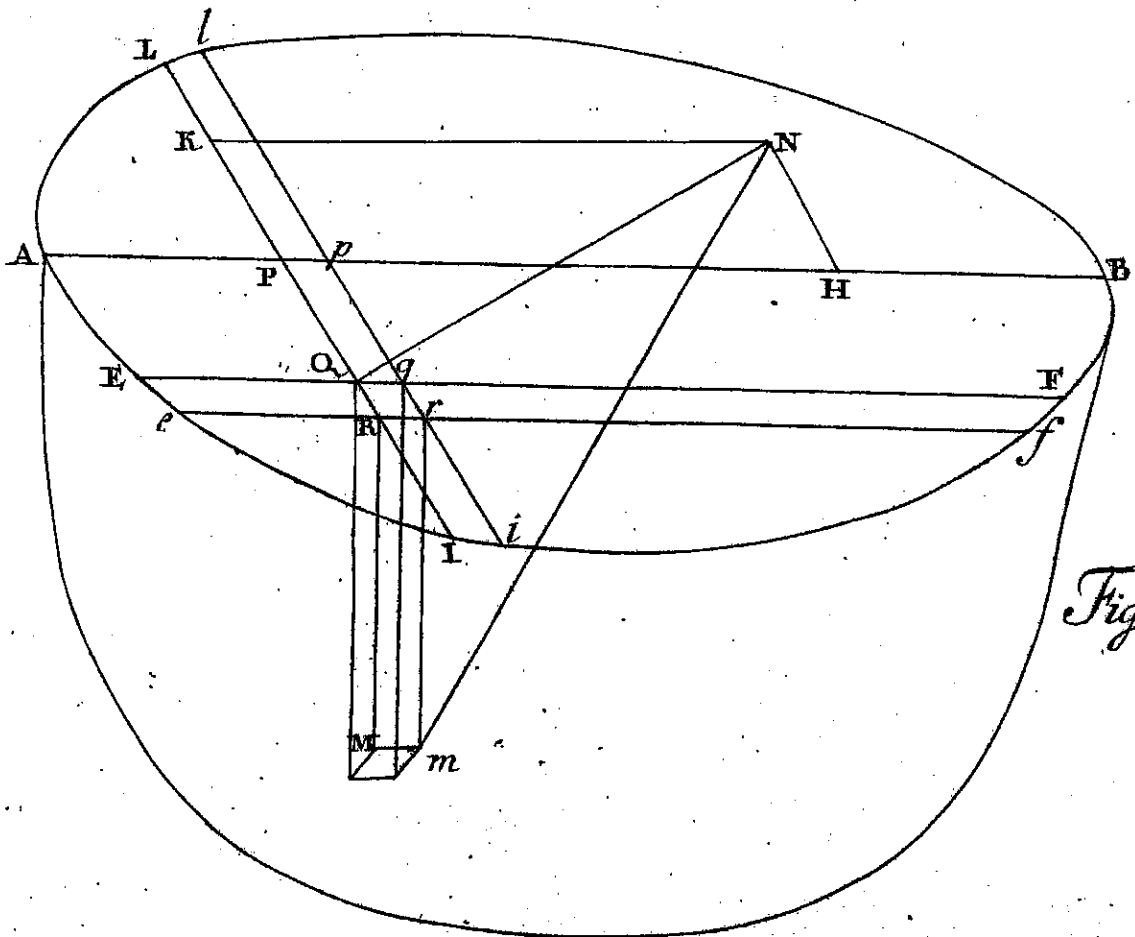

Fig. 2.

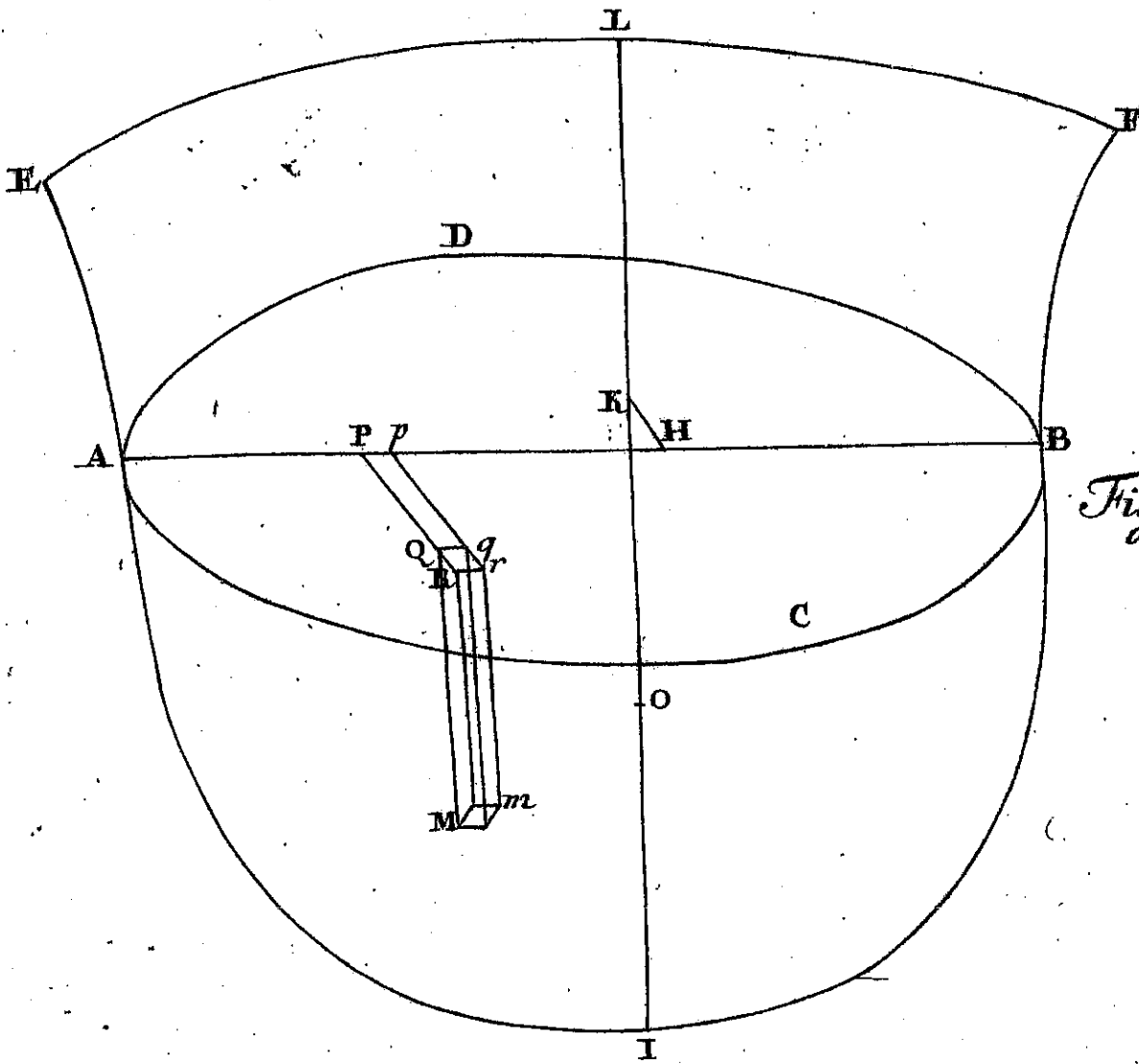

Fig. 1.

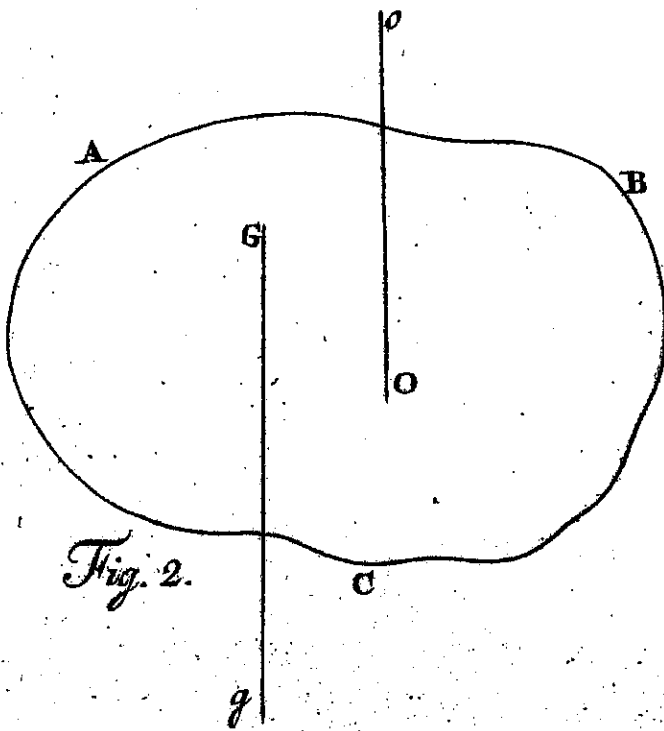

Fig. 2.

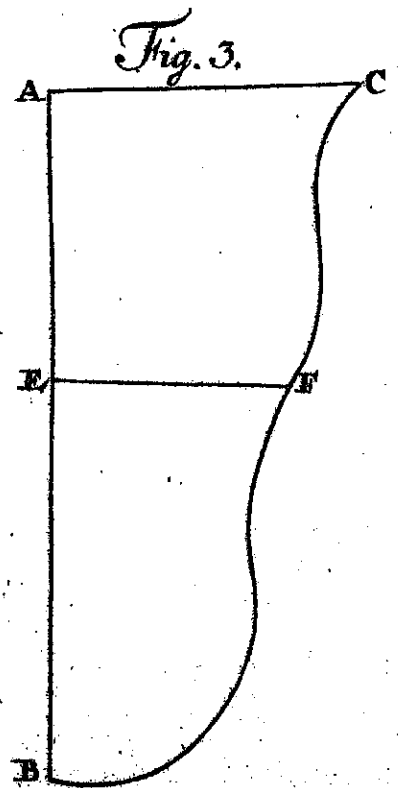
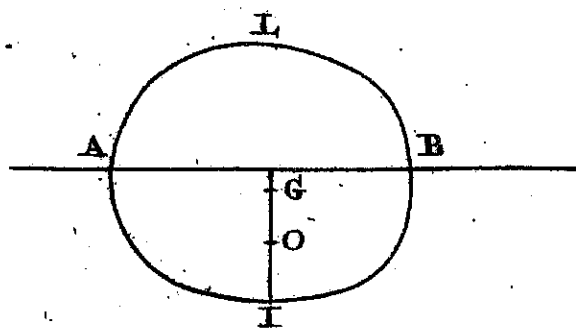
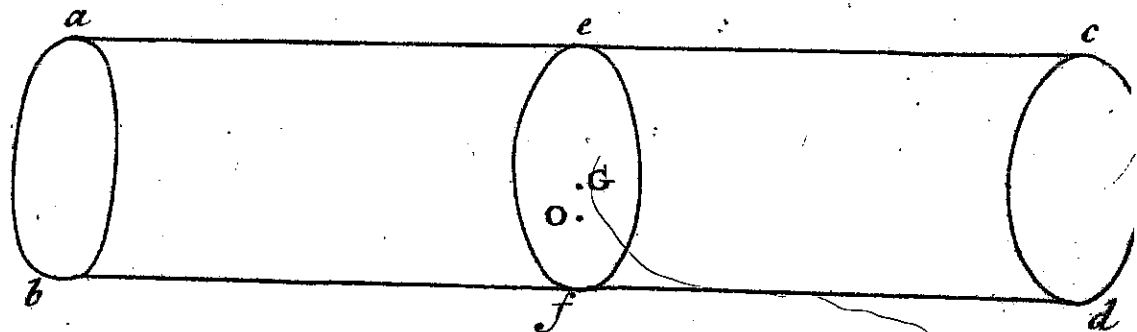
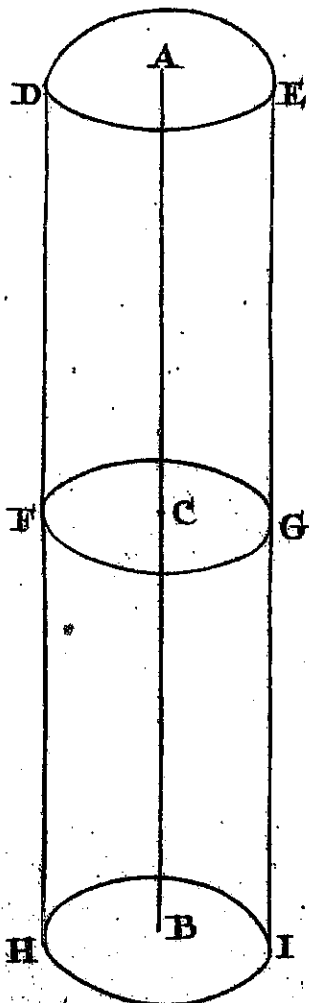
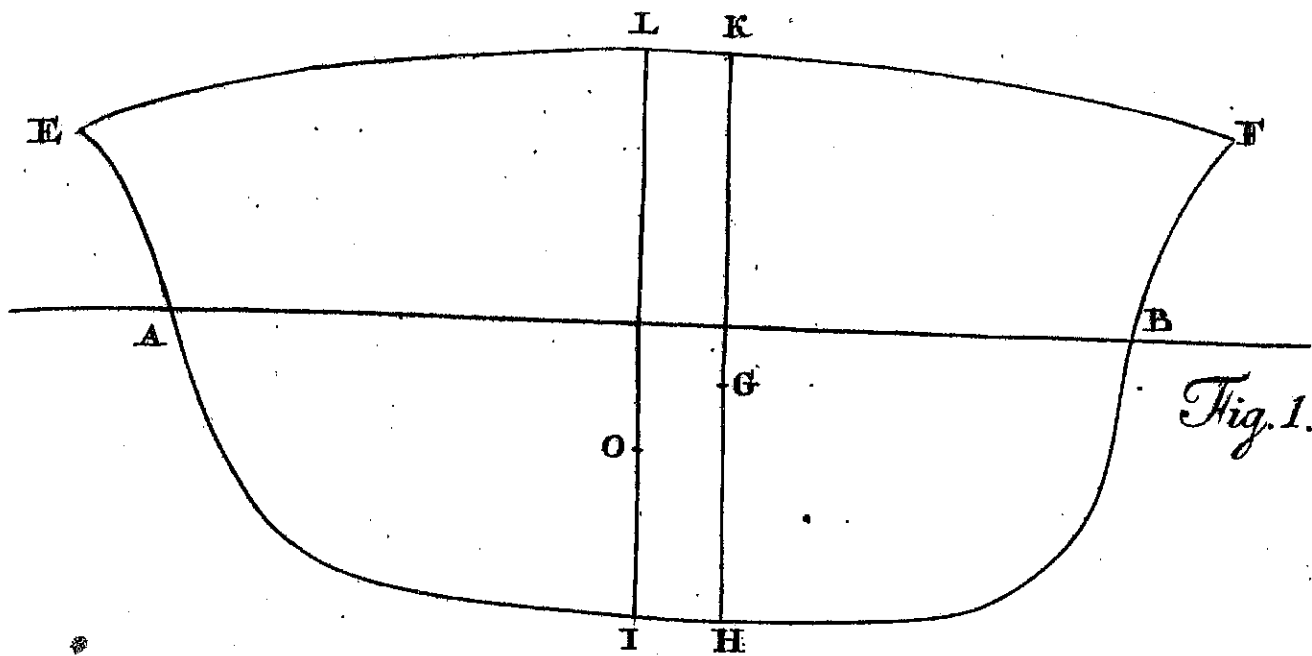

Fig. 3.



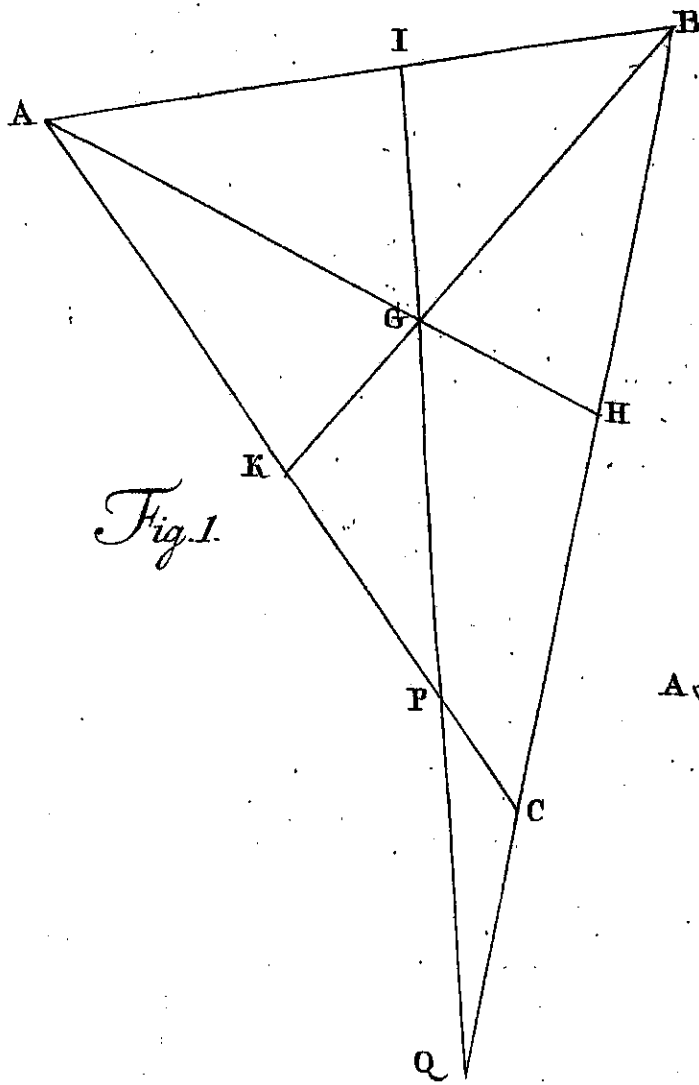

Fig. 1.

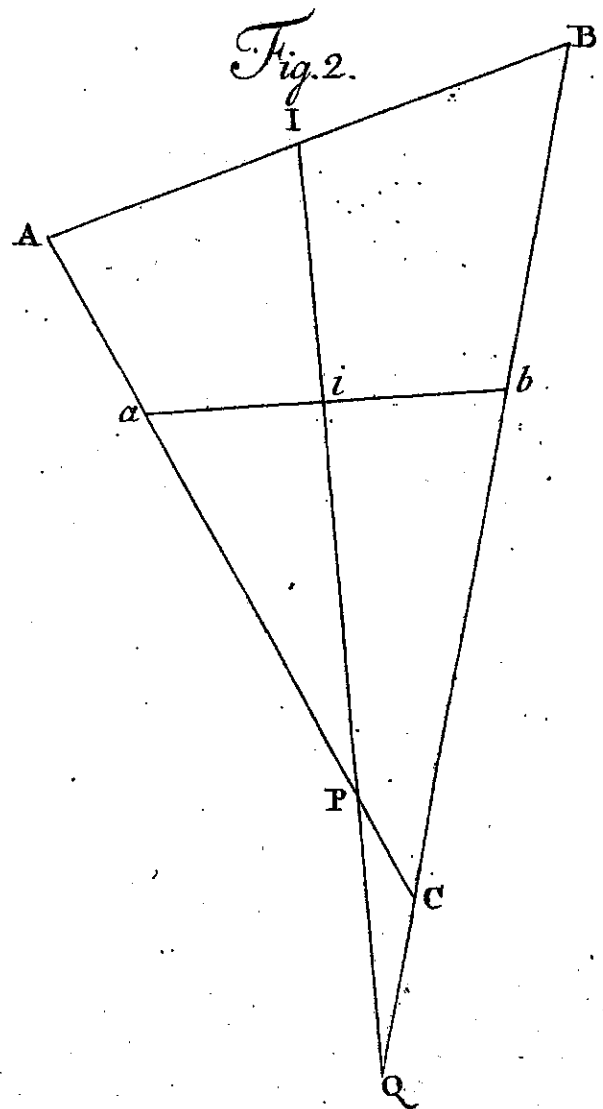

Fig. 2.

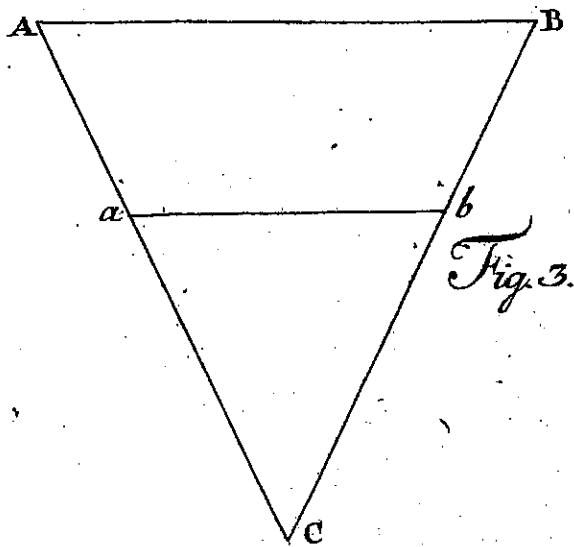

Fig. 3.

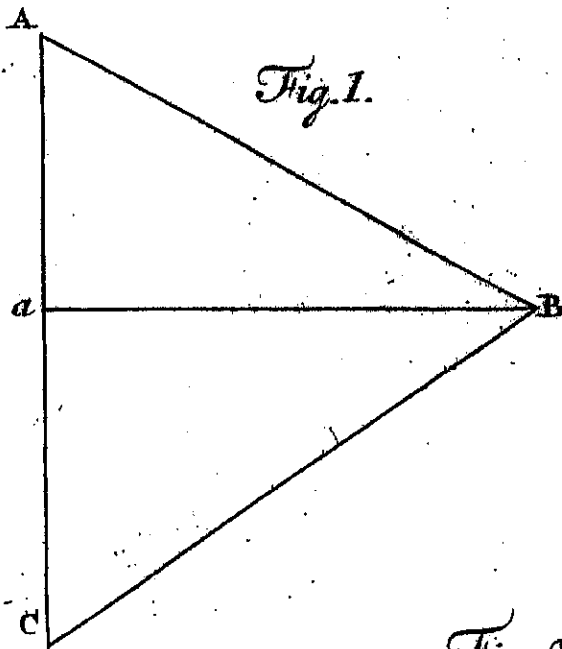

Fig. 2.

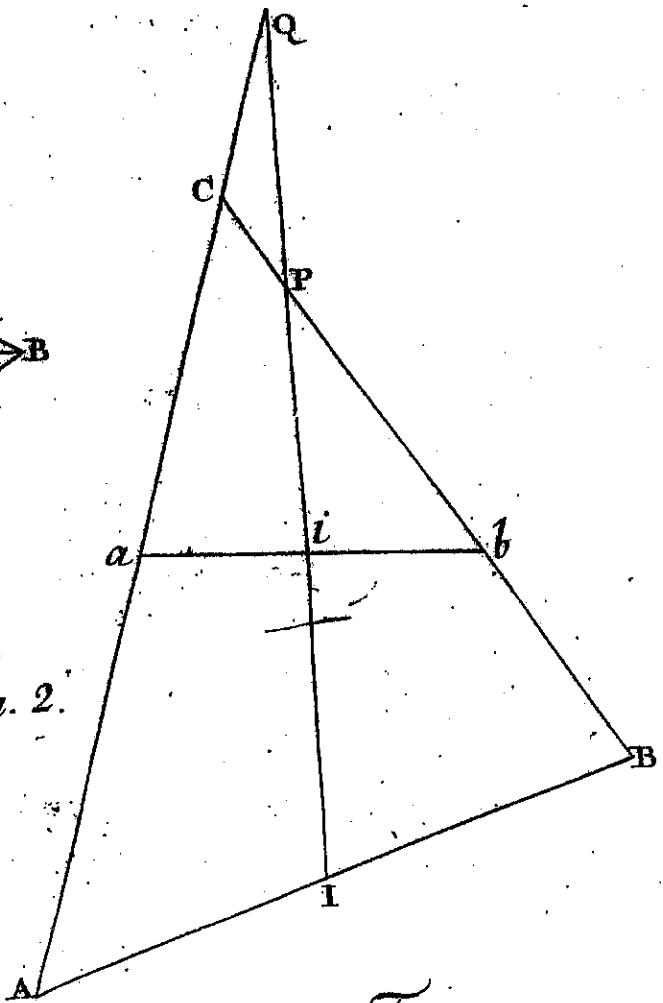
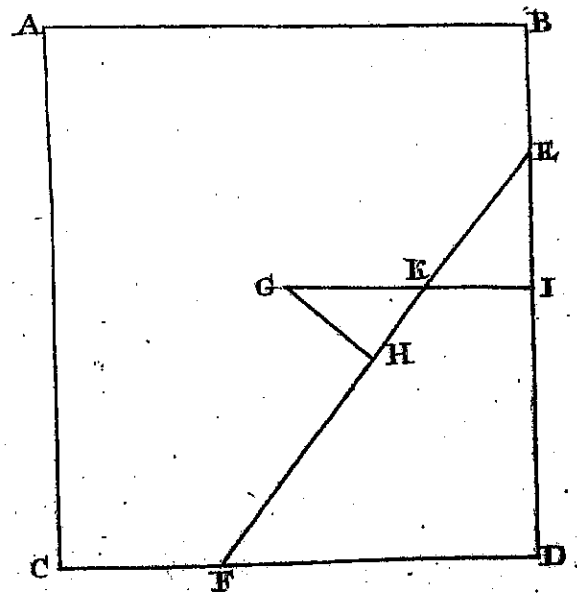
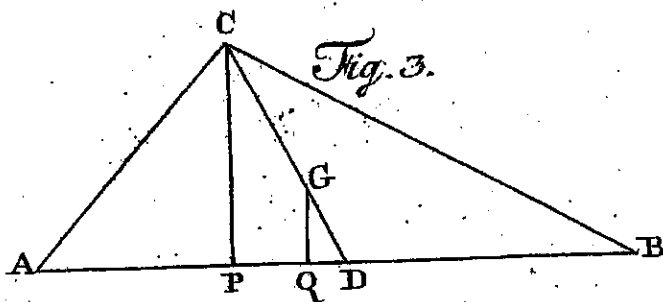
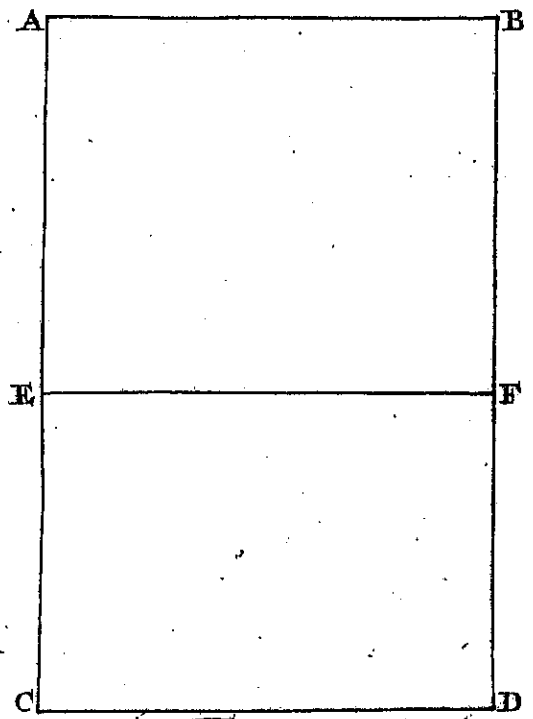
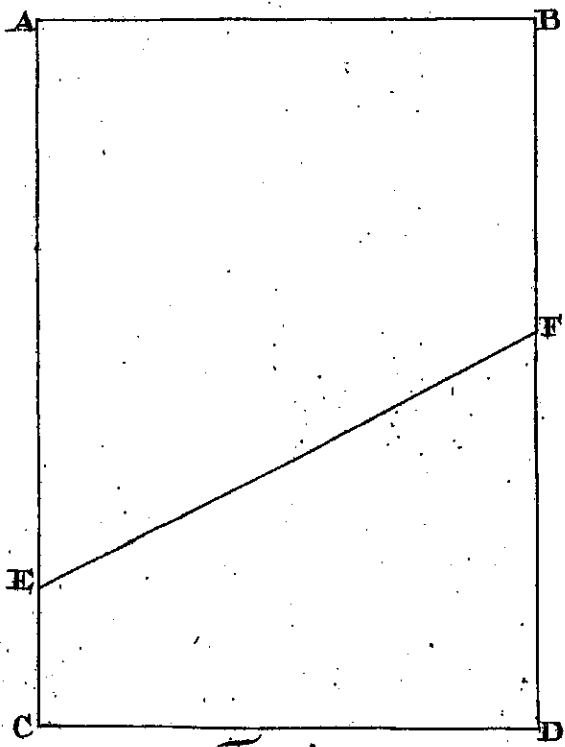
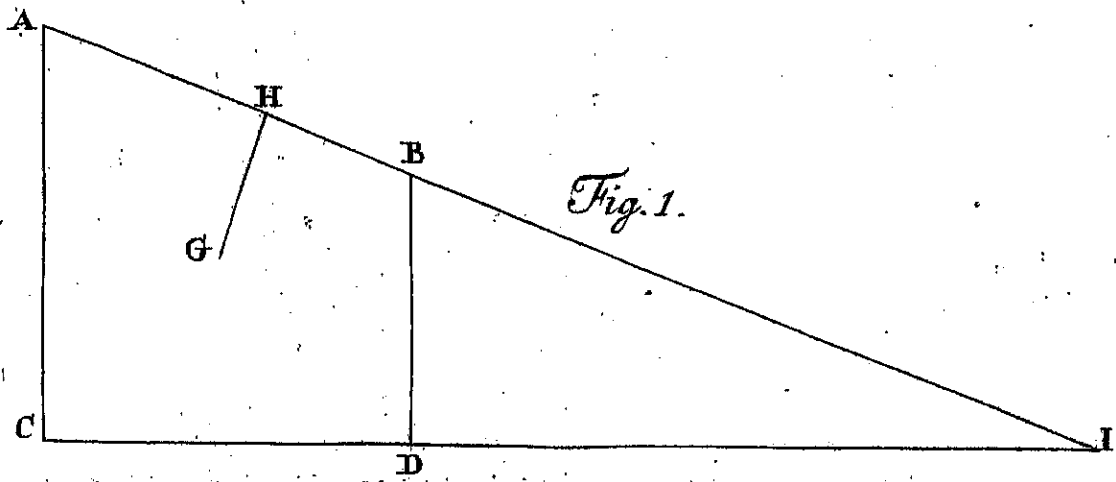
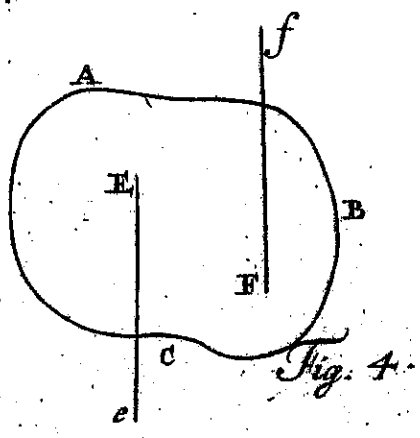
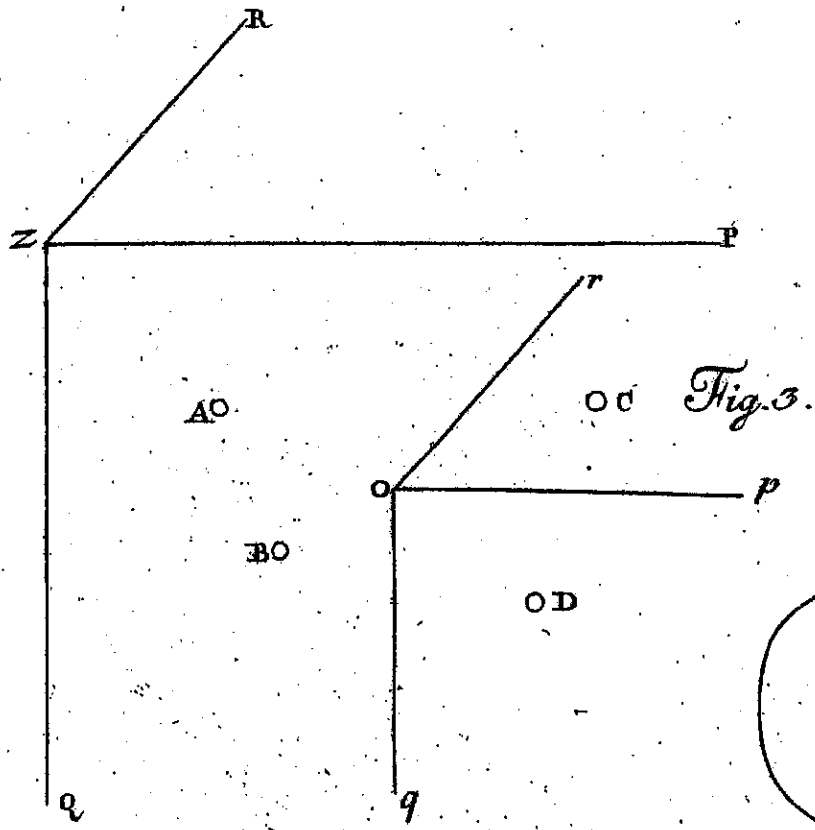
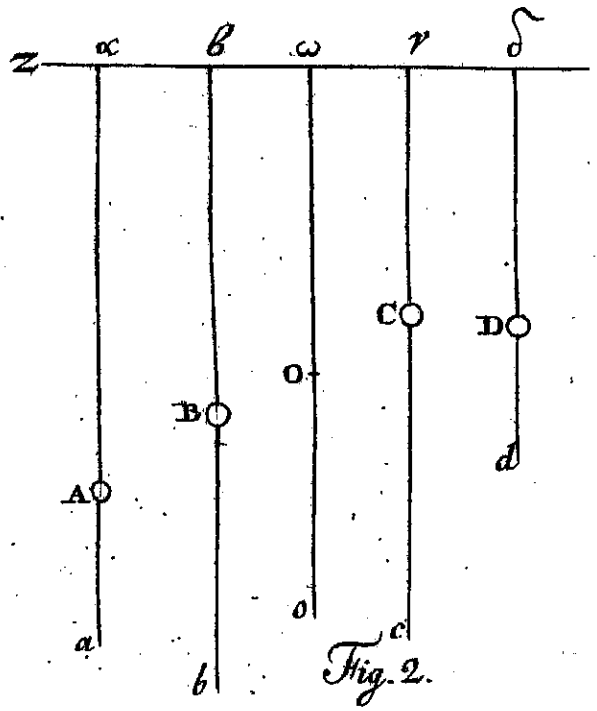
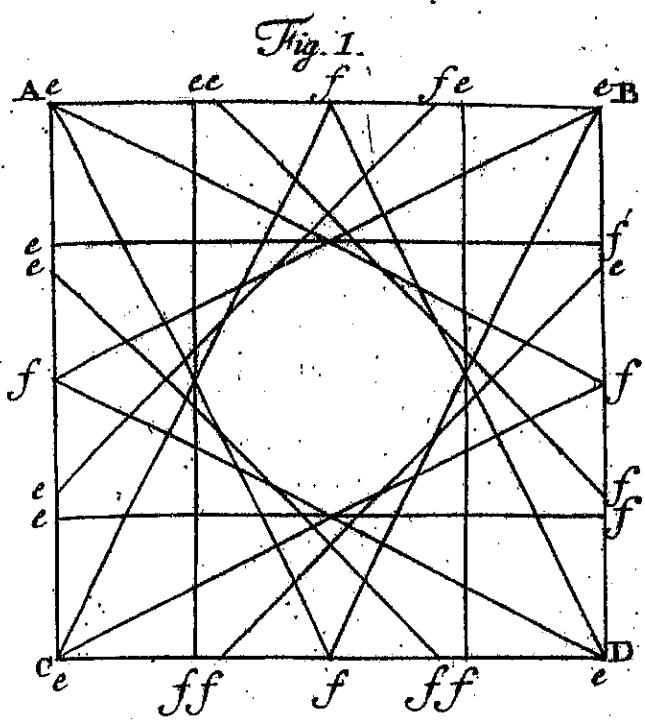

Fig. 4.







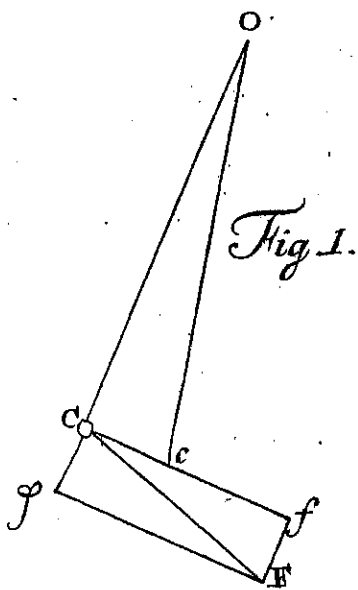

Fig. 1.

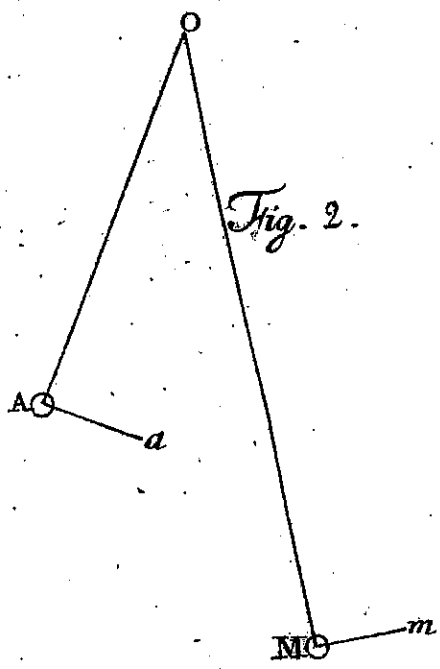

Fig. 2.

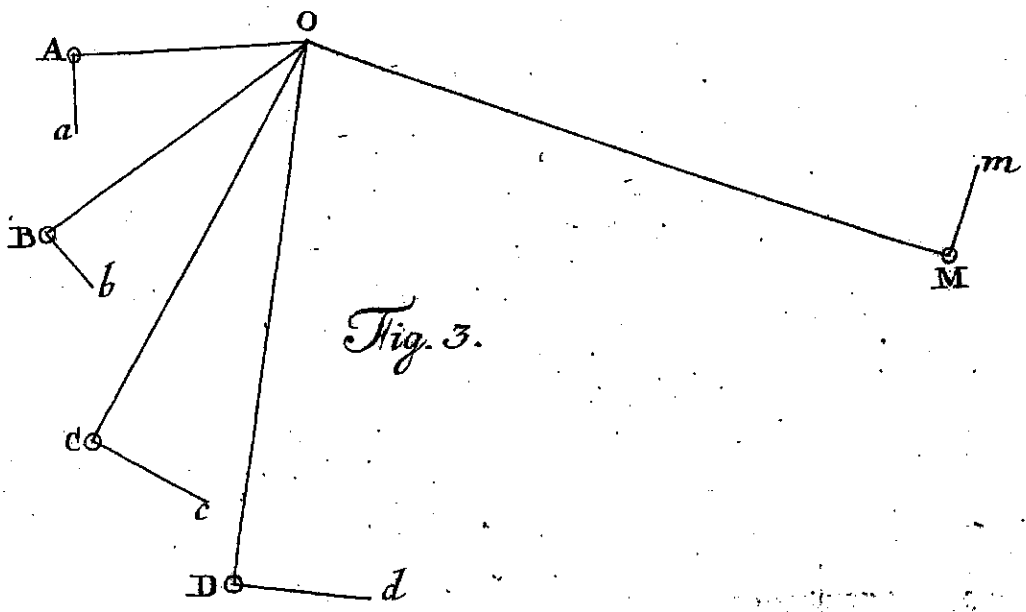
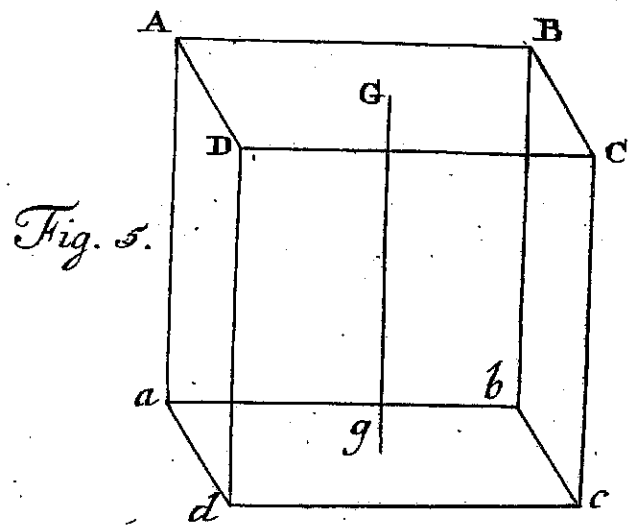
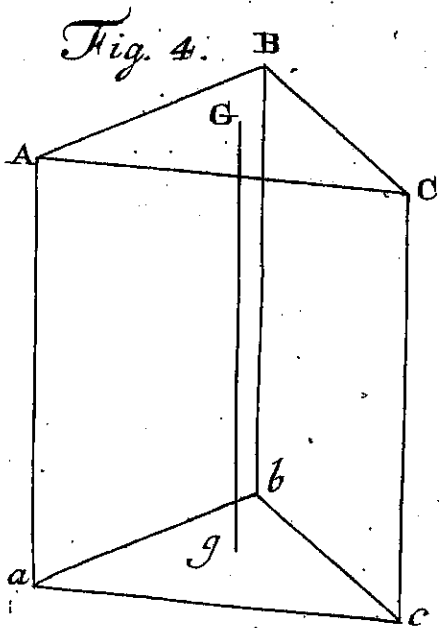
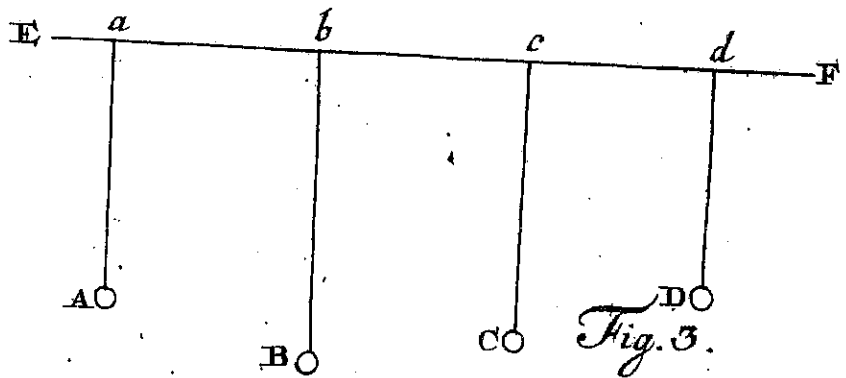
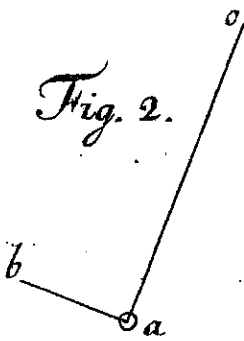
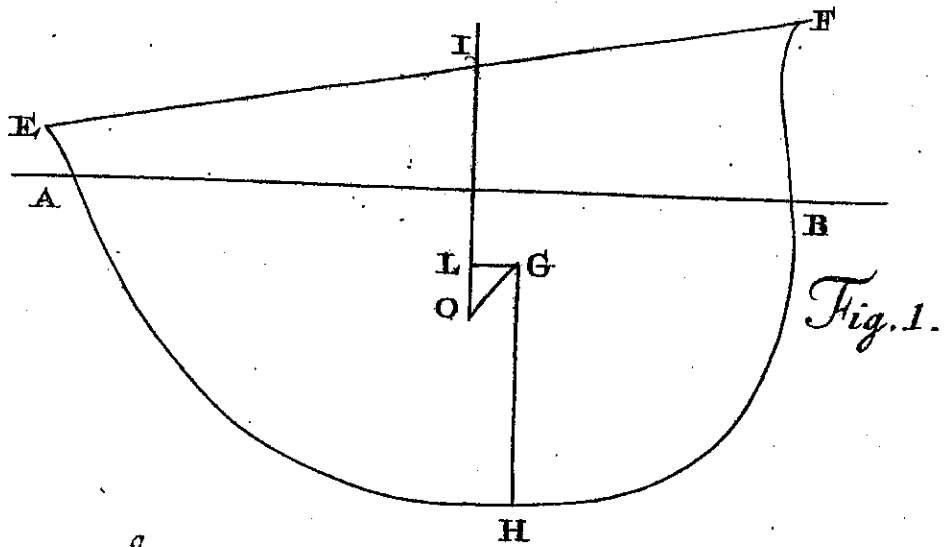
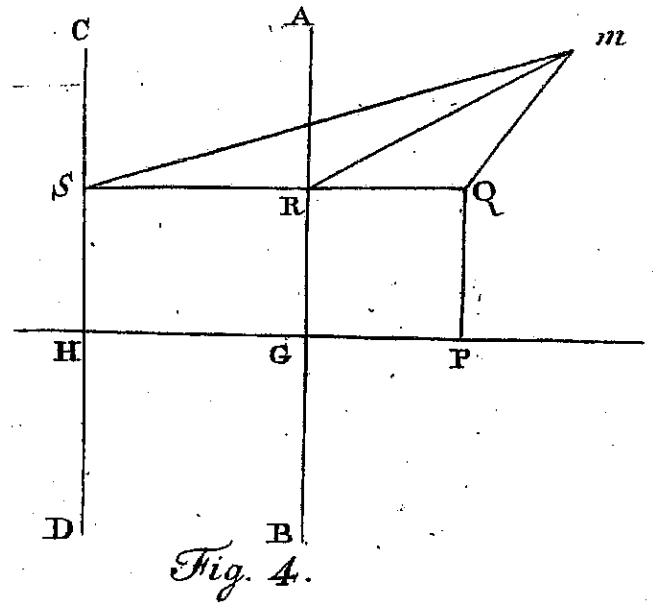
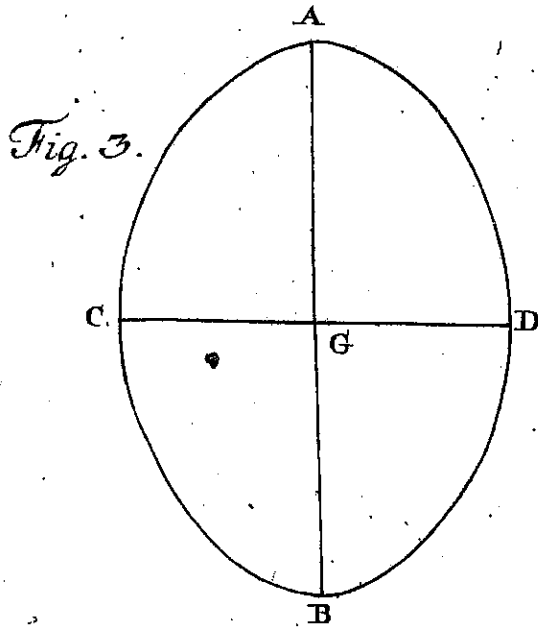
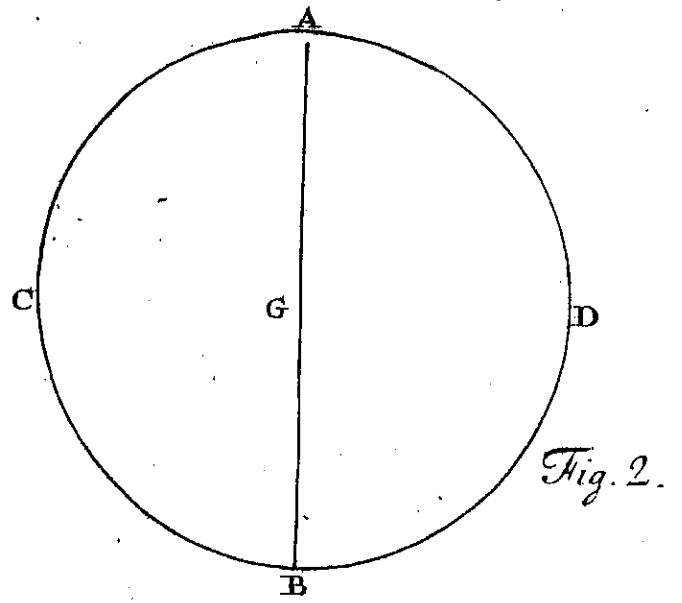
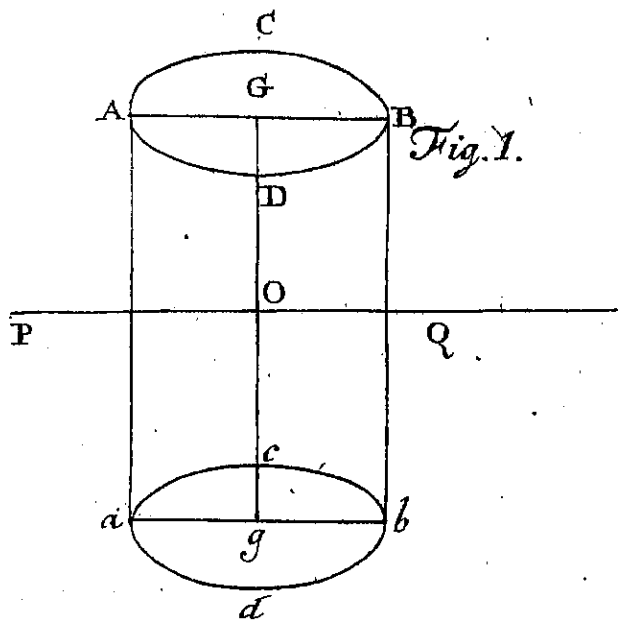

Fig. 3.





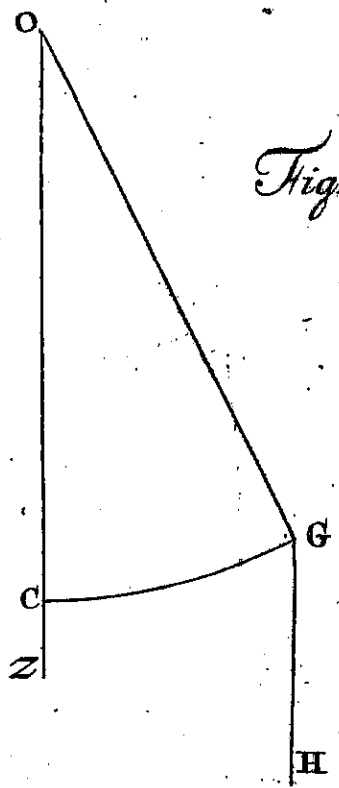

Fig. 1.

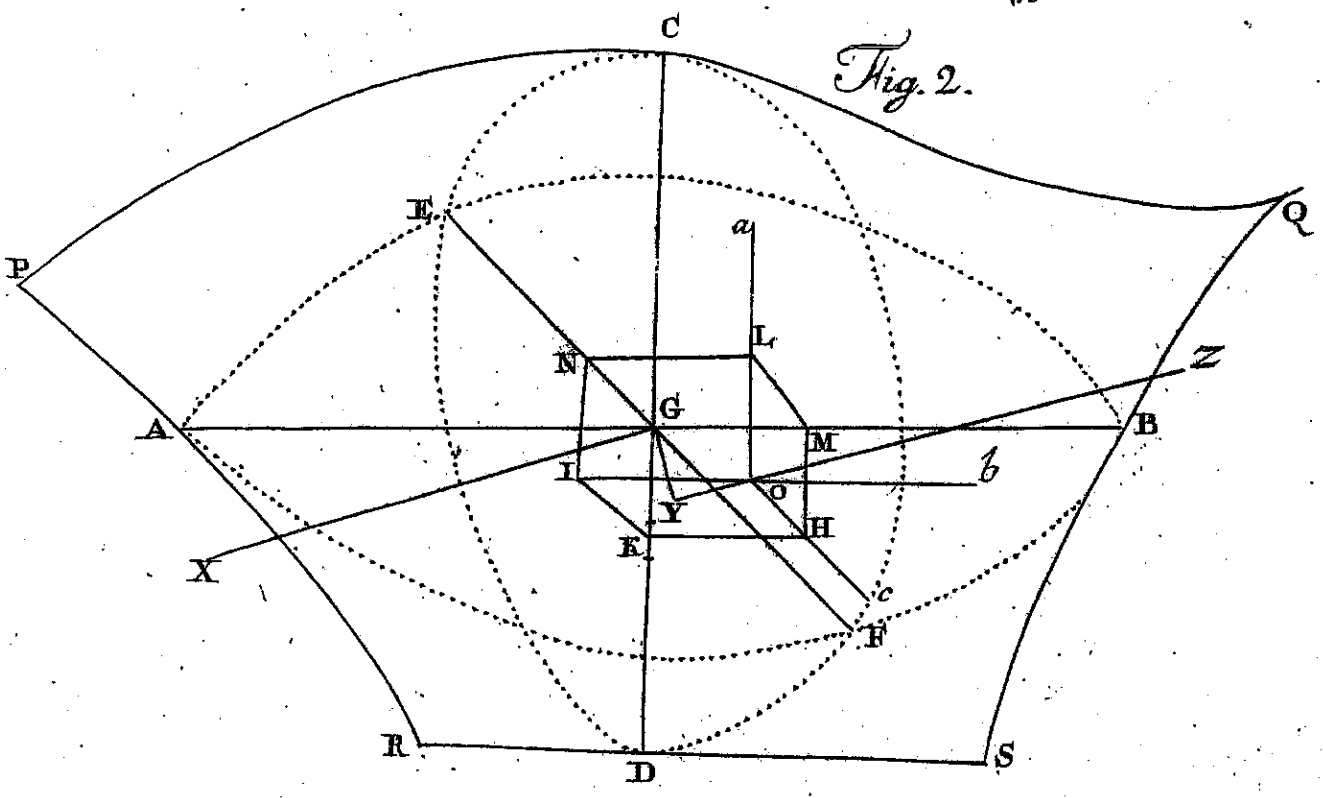
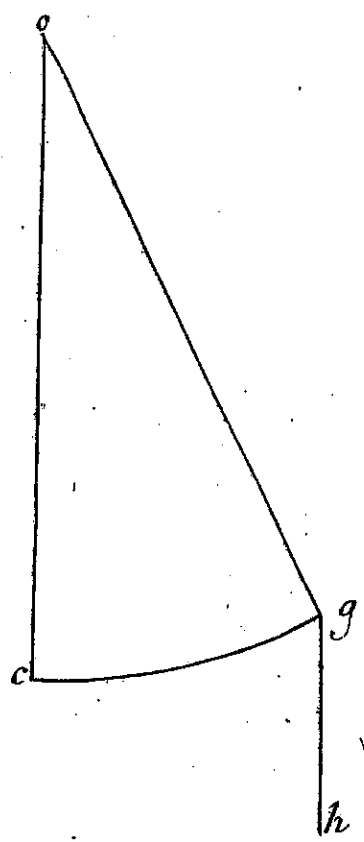

Fig. 2.

Fig. 1.

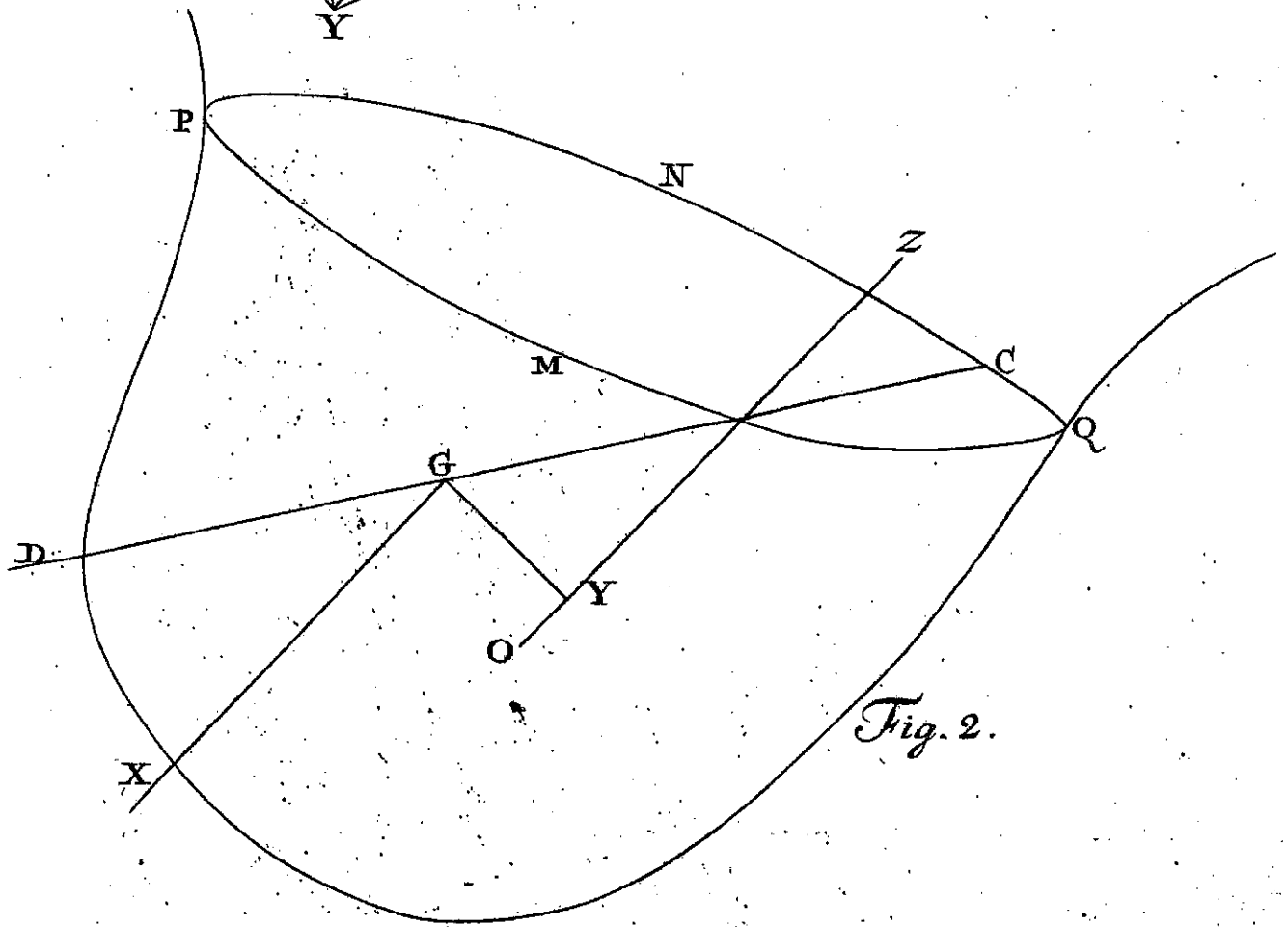
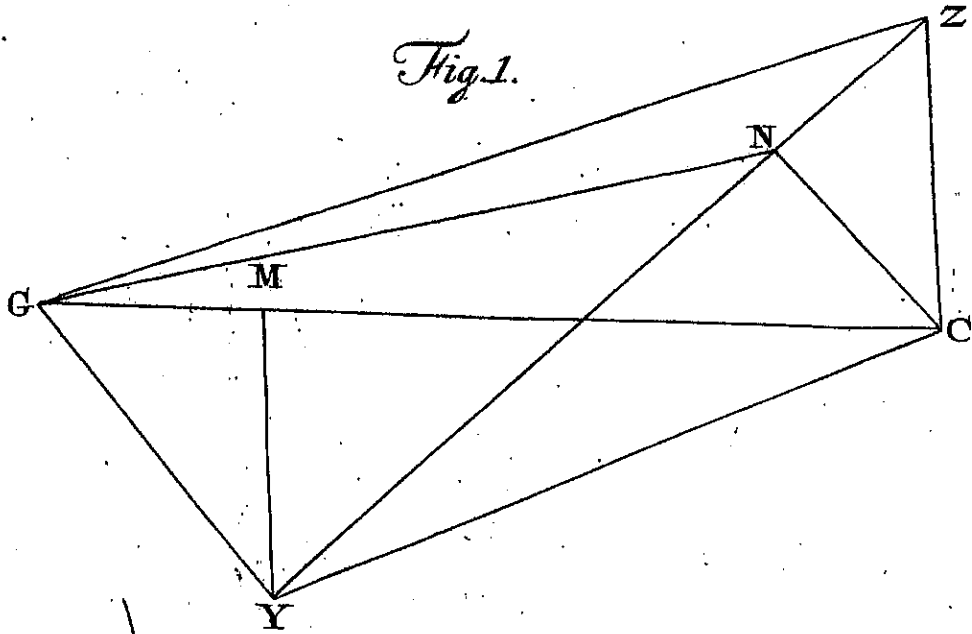

Fig. 2.

